

Catalogus / Prijslijst 2020



HOOFDSTUK	Pagina
1 - CV AANSLUITMATERIALEN	3
2 - ROOKGASKANALEN RVS DUBBELWANDIG	15
3 - ROOKGASKANALEN ENKELWANDIG	31
4 - ROOKGASKANALEN RVS CONCENTRISCH	57
5 - ROOKGASKANALEN RVS FLEXIBEL	63
6 - DAKKAPPEN / UITMONDINGEN	69
7 - RVS CLV - SYSTEMEN	75
8 - KACHELACCESSOIRES EN VEEGMATERIALEN	81
9 - ONDERDELEN INBOUW OPENHAARDEN	85
10 - VENTILATIEKANALEN GEGALVANISEERD EN KUNSTSTOF	89
11 - WOONHUISVENTILATIE / VENTILATIESYSTEMEN	107
12 - MEETINSTRUMENTEN / THERMOSTATEN	121
BIJLAGEN	124



HOOFDSTUK 1

CV Aansluitmaterialen

Omschrijving	Pagina
Kunststof RGA aansluitmateriaal star Ø 60 mm - Ø 80 mm - Ø 100 mm	4
Kunststof RGA aansluitmateriaal star Ø 130 mm - Ø 150 mm / Flex Ø 60 mm - Ø 80 mm	5
Kunststof RGA aansluitmateriaal flex Ø 80mm - Ø 100 mm / zwart LTV Ø 80 mm - 100 mm	7
RVS RGA aansluitmateriaal blank met siliconenring Ø 80 mm - Ø 100 mm - Ø 110 mm	8
Dikwandig Aluminium aansluitmateriaal met lipring Ø 80 mm (wit) - Ø 100 mm - Ø 110 mm	9
Dikwandig Aluminium met lipring Ø 130 mm - Ø 150 mm - Ø 180 mm - Ø 200 mm - Ø 250 mm	10
Concentrisch Twinsafe PP Ø 60/100 mm - Ø 80/125 mm - Ø 100/150 mm	11
Dakdoorvoeren - Muurdoorvoeren - Schoorsteentoppen - Accessoires - EPDM manchetten	12



ROOKGASKANALEN

CV Aansluitmateriaal Kunststof star

Wit Kunststof
Rookgasafvoer
Ø 80 mm



Artikelnr.	Omschrijving	Brutoprijs	Krt.G
5330000	Rolux PP R.G. Wit Ø 80 mm pijp L = 250 mm	7,70	A
5330010	Rolux PP R.G. Wit Ø 80 mm pijp L = 500 mm	10,40	A
5330020	Rolux PP R.G. Wit Ø 80 mm pijp L = 1000 mm	14,50	A
5330030	Rolux PP R.G. Wit Ø 80 mm pijp L = 2000 mm	29,30	A
5330070	Rolux PP R.G. Wit Ø 80 mm pijp L = 3000 mm	42,80	A
5330040	Rolux PP R.G. Wit Ø 80 mm bocht 45°	9,60	A
5330050	Rolux PP R.G. Wit Ø 80 mm bocht 87°	9,80	A
5330060	Rolux PP R.G. Wit Ø 80 mm beugel	4,90	A

Grijs Kunststof
Rookgasafvoer
Ø 60 mm



5332000	BH PP R.G. Grijs Ø 60 mm pijp L = 250 mm	8,00	A
5332010	BH PP R.G. Grijs Ø 60 mm pijp L = 500 mm	9,60	A
5332020	BH PP R.G. Grijs Ø 60 mm pijp L = 1000 mm	14,50	A
5332040	BH PP R.G. Grijs Ø 60 mm pijp L = 2000 mm	21,90	A
5332045	BH PP R.G. Grijs Ø 60 mm paspijp L = 285-395 mm	20,10	A
5332055	BH PP R.G. Grijs Ø 60 mm bocht 30°	12,60	A
5332050	BH PP R.G. Grijs Ø 60 mm bocht 45°	12,60	A
5332060	BH PP R.G. Grijs Ø 60 mm bocht 87°	11,60	A
5332070	BH PP R.G. Grijs vergroterend verloop Ø 60-80 mm	23,10	A
5332075	BH PP R.G. Grijs verkleinerend verloop Ø 80-60 mm	25,00	A
5330280	BH PP R.G. Grijs Ø 60 mm condensafvoer H/V	58,60	A
5330290	BH PP R.G. Grijs Ø 60 mm beugel	4,90	A

Grijs Kunststof
Rookgasafvoer
Ø 80 mm



5333000	BH PP R.G. Grijs Ø 80 mm pijp L = 250 mm	9,40	A
5333010	BH PP R.G. Grijs Ø 80 mm pijp L = 500 mm	11,30	A
5333020	BH PP R.G. Grijs Ø 80 mm pijp L = 1000 mm	17,00	A
5333040	BH PP R.G. Grijs Ø 80 mm pijp L = 2000 mm	31,60	A
5333045	BH PP R.G. Grijs Ø 80 mm paspijp L = 285-395 mm	51,80	A
5333035	BH PP R.G. Grijs Ø 80 mm bocht 30°	12,10	A
5333050	BH PP R.G. Grijs Ø 80 mm bocht 45°	10,40	A
5333060	BH PP R.G. Grijs Ø 80 mm bocht 87°	11,10	A
5333070	BH PP R.G. Grijs vergroterend verloop Ø 80-100 mm	20,10	A
5333075	BH PP R.G. Grijs verkleinerend verloop Ø 100-80 mm	20,10	A
5333080	BH PP R.G. Grijs Ø 80 mm condensafvoer H/V	51,90	A
5333090	BH PP R.G. Grijs Ø 80 mm beugel	4,10	A

Grijs Kunststof
Rookgasafvoer
Ø 100 mm



5330715	BH PP R.G. Grijs Ø 100 mm pijp L = 250 mm	10,50	A
5330710	BH PP R.G. Grijs Ø 100 mm pijp L = 500 mm	14,10	A
5330700	BH PP R.G. Grijs Ø 100 mm pijp L = 1000 mm	19,90	A
5330730	BH PP R.G. Grijs Ø 100 mm pijp L = 2000 mm	33,20	A
5330735	BH PP R.G. Grijs Ø 100 mm paspijp L = 285-395 mm	35,90	A
5330745	BH PP R.G. Grijs Ø 100 mm bocht 30°	23,50	A
5330740	BH PP R.G. Grijs Ø 100 mm bocht 45°	23,50	A
5330750	BH PP R.G. Grijs Ø 100 mm bocht 87°	22,70	A
5330780	BH PP R.G. Grijs Ø 100 mm condensafvoer H/V	57,90	A
5330760	BH PP R.G. Grijs Ø 100 mm beugel	5,70	A
5333070	BH PP R.G. Grijs vergroterend verloop Ø 80-100 mm	20,10	A
5333075	BH PP R.G. Grijs verkleinerend verloop Ø 100-80 mm	20,10	A
5331490	BH PP R.G. Grijs vergroterend verloop Ø 100-130 mm	100,30	A
5330770	BH PP R.G. Grijs verkleinerend verloop Ø 130-100 mm	103,30	A

ROOKGASKANALEN

CV Aansluitmateriaal Kunststof star en flexibel

Grijs Kunststof
Rookgasafvoer
Ø 130 mm



Artikelnr.	Omschrijving	Brutoprijs	Krt.G
5333100	BH PP R.G. Grijs Ø 130 mm pijp L = 250 mm	30,30	A
5333110	BH PP R.G. Grijs Ø 130 mm pijp L = 500 mm	38,40	A
5333120	BH PP R.G. Grijs Ø 130 mm pijp L = 1000 mm	59,30	A
5333130	BH PP R.G. Grijs Ø 130 mm pijp L = 2000 mm	88,80	A
5333140	BH PP R.G. Grijs Ø 130 mm paspijp L = 285-395 mm	92,80	A
5333150	BH PP R.G. Grijs Ø 130 mm bocht 30°	64,50	A
5333160	BH PP R.G. Grijs Ø 130 mm bocht 45°	37,30	A
5333170	BH PP R.G. Grijs Ø 130 mm bocht 87°	40,70	A
5333180	BH PP R.G. Grijs Ø 130 mm condensafvoer H/V	100,80	A
5333190	BH PP R.G. Grijs Ø 130 mm beugel (aluminium)	7,00	A
5330777	BH PP R.G. Grijs vergrotend verloop Ø 130-150 mm	103,40	A

Grijs Kunststof
Rookgasafvoer
Ø 150 mm



5333200	BH PP R.G. Grijs Ø 150 mm pijp L = 250 mm	41,70	A
5333210	BH PP R.G. Grijs Ø 150 mm pijp L = 500 mm	52,70	A
5333220	BH PP R.G. Grijs Ø 150 mm pijp L = 1000 mm	72,50	A
5333230	BH PP R.G. Grijs Ø 150 mm pijp L = 2000 mm	118,90	A
5333240	BH PP R.G. Grijs Ø 150 mm paspijp L = 295-415 mm	100,20	A
5333250	BH PP R.G. Grijs Ø 150 mm bocht 30°	70,30	A
5333260	BH PP R.G. Grijs Ø 150 mm bocht 45°	48,80	A
5333270	BH PP R.G. Grijs Ø 150 mm bocht 87°	53,90	A
5333280	BH PP R.G. Grijs Ø 150 mm condensafvoer H/V	108,80	A
5333290	BH PP R.G. Grijs Ø 150 mm beugel (aluminium)	7,20	A
5330775	BH PP R.G. Grijs verkleinend verloop Ø 150-130 mm	145,50	A

BH Miniflex Ø 60 mm



5331000	BH Miniflex Ø 60 mm pijp L = 10 meter	267,10	A
5331010	BH Miniflex Ø 60 mm pijp L = 25 meter	498,30	A
5331020	BH Miniflex Ø 60 mm pijp L = 50 meter	996,70	A
5331030	BH Miniflex Ø 60 mm koppelsset spie-flex/flex-mof	51,80	A
5331040	BH Miniflex verloop Ø 80-60 mm verkleinend	25,80	A
5331050	BH Miniflex verloop Ø 60-80 mm vergrotend	23,10	A
5331060	BH Miniflex Ø 60 mm verlengde bocht 90° L=595 mm	71,50	A
5331070	BH Miniflex Ø 60 mm koppelsstuk flex-flex	44,60	A
5331080	BH Miniflex Ø 60 mm uitmondingsset Skyline	52,40	A
5331090	BH Miniflex plakplaat uitmondingsset	46,50	A
5331095	BH Miniflex Ø 60 mm renovatieset prefab	64,30	A

BH PP Flex Ø 80 mm



5331100	BH PP Flex Ø 80 mm pijp L = 10 meter	227,80	A
5331110	BH PP Flex Ø 80 mm pijp L = 25 meter	569,50	A
5331120	BH PP Flex Ø 80 mm pijp L = 50 meter	1139,00	A
5331130	BH PP Flex Ø 80 mm verlengde bocht 90° L=300 mm	93,30	A
5331140	BH PP Flex Ø 80 mm koppelsstuk flex/mof (Boven)	40,40	A
5331150	BH PP Flex Ø 80 mm koppelsstuk spie/flex (Onder)	36,70	A
5331160	BH PP Flex Ø 80 mm koppelsstuk flex/flex	40,40	A
5331170	BH PP Flex Ø 80 mm schoorsteenkap compleet	139,60	A
5331180	BH PP Flex Ø 80 mm uitmondingsset Skyline	63,70	A
5331090	BH Miniflex plakplaat uitmondingsset	46,50	A
5331190	BH PP Flex Ø 80 mm bocht 90° met steun	16,60	A
5331200	BH PP Flex Ø 80 / Ø 100 mm afstandhouder	6,90	A
5331040	BH Miniflex verloop Ø 80-60 mm verkleinend	25,80	A
5331050	BH Miniflex verloop Ø 60-80 mm vergrotend	23,10	A
5331210	BH PP Flex Ø 80 mm afdekplaat 220x220 mm	36,70	A
5331220	BH PP Flex Ø 80 mm montageset (15 mtr)	73,90	A

Ubbink 5-serie

High five voor prestatie en design!



ub bink

➤ Complete lijn dakdoorvoeren voor een beter resultaat en uiterlijk!

De 5-serie van Ubbink is een complete lijn dakdoorvoeren, waarbij design is gecombineerd met topprestaties! Oplossingen voor rookgasafvoer van de HR ketel, mechanische ventilatie, rioolbeluchting of combinaties daarvan.

De dakdoorvoeren kenmerken zich door veiligheid, duurzaamheid én installatiegemak. Dankzij de gepatenteerde spiraaltechniek zijn de doorvoeren gemiddeld 20% compacter dan andere modellen op de markt. Ook verkrijgbaar in verlengde uitvoeringen. Kies voor de 5-serie voor een beter resultaat én slank uiterlijk op uw dak! Download uw BIM tekeningen via www.ubbink.nl/bim.

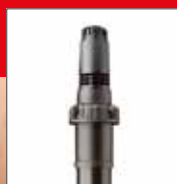

Rolux 5G Combi



Rolux 5G



SoloVent 5R



MultiVent 5V



MultiVent 5V Combi



Ubbink, dat werkt wel zo makkelijk!

www.ubbink5serie.nl

ROOKGASKANALEN

CV Aansluitmateriaal Kunststof flex en LTV

BH PP Flex Ø 100 mm



Artikelnr.	Omschrijving	Brutoprijs	Krt.G
5331300	BH PP Flex Ø 100 mm pijp L = 10 meter	256,30	A
5331310	BH PP Flex Ø 100 mm pijp L = 25 meter	640,70	A
5331320	BH PP Flex Ø 100 mm koppelstuk flex/mof (boven)	42,50	A
5331330	BH PP Flex Ø 100 mm koppelstuk spie/flex (onder)	38,30	A
5331340	BH PP Flex Ø 100 mm koppelstuk flex/flex	42,50	A
5331350	BH PP Flex Ø 100 mm schoorsteenkap compleet	188,90	A
5331360	BH PP Flex Ø 100 mm bocht 90° met steun	25,10	A
5331200	BH PP Flex Ø 80 / Ø 100 mm afstandhouder	6,90	A
5331370	BH PP Flex Ø 100 mm montageset (15 mtr)	77,30	A
5331380	BH PP Flex Ø 100 mm Condensafvoer H/V	58,00	A
5331390	BH PP verloop Ø 80-100 mm vergrotend	20,10	A

Kunststof Flex Rolux Ø 80 mm



5330500	Kunststof Flex Rolux pijp Ø 80 mm L = 12,50 meter	287,30	A
5330505	Kunststof Flex Rolux pijp Ø 80 mm L = 25 meter	565,70	A
5330515	Kunststof Flex Rolux pijp Ø 80 mm L = 50 meter	1108,90	A
5330510	Kunststof Flex Rolux grespotkap Ø 80mm	79,20	A
5330525	Kunststof Flex Rolux schoorsteenopst. open Ø 80mm	84,50	A
5330520	Kunststof Flex Rolux afstandhouder Ø 80mm (6 stuks)	43,60	A
5330530	Kunststof Flex Rolux bocht DN80 + schoorsteensteun	70,20	A
5330540	Kunststof Flex Rolux koppelstuk flex-flex Ø 80 mm	49,00	A
5330540	Kunststof Flex Rolux muurplaat + schachtaansl. 80-80	32,20	A

Kunststof zwart Luchtoevoer Ø 80 mm



5300000	PPS Ø 80 mm LTV zwart pijp L= 250 mm	7,80	A
5300010	PPS Ø 80 mm LTV zwart pijp L= 500 mm	10,40	A
5300020	PPS Ø 80 mm LTV zwart pijp L= 1000 mm	16,00	A
5300030	PPS Ø 80 mm LTV zwart pijp L= 2000 mm	25,20	A
5300040	PPS Ø 80 mm LTV zwart pijp L= 3000 mm	36,80	A
5300050	PPS Ø 80 mm LTV zwart bocht 87°	7,10	A
5300060	PPS Ø 80 mm LTV zwart bocht 45°	5,40	A
5300045	PPS Ø 80 mm LTV zwart beugel	4,40	A
5300070	Muurdoorvoer LTV Ø 80 mm	87,40	A

Kunststof zwart Luchtoevoer Ø 100 mm



5300005	PPS Ø 100 mm LTV zwart pijp L= 250 mm	10,90	A
5300015	PPS Ø 100 mm LTV zwart pijp L= 500 mm	14,90	A
5300025	PPS Ø 100 mm LTV zwart pijp L= 1000 mm	22,50	A
5300035	PPS Ø 100 mm LTV zwart pijp L= 2000 mm	38,10	A
5300055	PPS Ø 100 mm LTV zwart bocht 87°	9,70	A
5300065	PPS Ø 100 mm LTV zwart bocht 45°	8,80	A
5300075	PPS Ø 100 mm LTV zwart beugel	5,90	A

ROOKGASKANALEN

CV Aansluitmateriaal RVS met siliconering

RVS Ø 80 mm
met lipring



Artikelnr.	Omschrijving	Brutoprijs	Krt.G
1212000	RVS EW Ø 80 mm pijp L = 1000 mm	34,00	A
1212010	RVS EW Ø 80 mm pijp L = 500 mm	25,50	A
1212020	RVS EW Ø 80 mm pijp L = 250 mm	21,00	A
1212130	RVS EW Ø 80 mm paspijp 330 mm	22,60	A
1212030	RVS EW Ø 80 mm bocht 30°	24,60	A
1212040	RVS EW Ø 80 mm bocht 45°	25,70	A
1212050	RVS EW Ø 80 mm bocht 90°	28,00	A
1212060	RVS EW Ø 80 mm T-stuk 90° M/S/S	55,60	A
1212070	RVS EW Ø 80 mm T-stuk 90° M/M/S	62,80	A
1212080	RVS EW Ø 80 mm dop voor T-stuk	18,80	A
1212090	RVS EW Ø 80 mm dop met condensafvoer	21,10	A
1212100	RVS EW Ø 80 mm muurbeugel	34,50	A
1212110	RVS EW Ø 80 mm mof M/M	16,60	A
1212120	RVS EW Ø 80 mm trekkap	62,70	A
1411150	RVS EW Ø 80 mm stormkraag	12,50	A
1411300	RVS EW verloop Ø 80 - 100 mm vergotend	48,80	A
1212150	RVS EW Ø 80 mm rozet	33,80	A

RVS Ø 100 mm
met lipring



1212200	RVS EW Ø 100 mm pijp L= 1000 mm	42,50	A
1212210	RVS EW Ø 100 mm pijp L = 500 mm	29,30	A
1212220	RVS EW Ø 100 mm pijp L = 250 mm	26,00	A
1212230	RVS EW Ø 100 mm paspijp 330 mm	28,00	A
1212240	RVS EW Ø 100 mm bocht 30°	30,60	A
1212250	RVS EW Ø 100 mm bocht 45°	32,20	A
1212260	RVS EW Ø 100 mm bocht 90°	35,40	A
1212270	RVS EW Ø 100 mm T-stuk 90°	60,00	A
1212280	RVS EW Ø 100 mm dop voor T-stuk	21,10	A
1212290	RVS EW Ø 100 mm dop met condensafvoer	23,30	A
1212300	RVS EW Ø 100 mm muurbeugel	39,90	A
1212310	RVS EW Ø 100 mm trekkap	69,30	A
1212330	RVS EW Ø 100 mm mof M/M	21,10	A
1411350	RVS EW Ø 100 mm stormkraag	14,40	A
1212350	RVS EW Ø 100 mm rozet	34,60	A
1411300	RVS EW verloop Ø 80 - 100 mm vergrotend	48,80	A

RVS Ø 110 mm
met lipring



1212600	RVS EW Ø 110 mm pijp L = 1000 mm	46,80	A
1212610	RVS EW Ø 110 mm pijp L = 500 mm	34,90	A
1212620	RVS EW Ø 110 mm pijp L = 250 mm	28,90	A
1212630	RVS EW Ø 110 mm Paspijp 330 mm	30,90	A
1212640	RVS EW Ø 110 mm bocht 30°	34,10	A
1212650	RVS EW Ø 110 mm bocht 45°	35,80	A
1212660	RVS EW Ø 110 mm bocht 90°	39,40	A
1212670	RVS EW Ø 110 mm trekkap	74,90	A
1212680	RVS EW Ø 110 mm muurbeugel	41,50	A
1212360	RVS EW Ø 110 mm rozet	35,00	A

ROOKGASKANALEN

CV Aansluitmateriaal Dikwandig Aluminium

Dikw. Alu. Ø 80 mm



Artikelnr.	Omschrijving	Brutoprijs	Krt.G
5200300	Dikw. Aluminium Ø 80 mm pijp L= 250 mm	13,50	A
5200310	Dikw. Aluminium Ø 80 mm pijp L= 500 mm	19,90	A
5200320	Dikw. Aluminium Ø 80 mm pijp L= 1000 mm	29,50	A
5200340	Dikw. Aluminium Ø 80 mm pijp L= 2000 mm	57,40	A
5200350	Dikw. Aluminium Ø 80 mm pijp L= 3000 mm	83,90	A
5200370	Dikw. Aluminium Ø 80 mm bocht 87°	22,50	A
5200380	Dikw. Aluminium Ø 80 mm bocht 43°	19,90	A
5200390	Dikw. Aluminium Ø 80 mm lippenring	4,20	A
5200400	Dikw. Aluminium Ø 80 mm koppelstuk	24,20	A
5200410	Dikw. Aluminium Ø 80 mm condensafvoer H/V	95,50	A
5201530	Dikw. Aluminium verloopstuk vergrotend Ø 80 - 90 mm	28,90	A
5201521	Dikw. Aluminium verloopstuk verkleinend Ø 90 - 80 mm	28,90	A
5201520	Dikw. Aluminium verloopstuk vergrotend Ø 80 - 100 mm	30,00	A
5201700	Aluminium Beugel Ø 80 mm moer M8	4,90	A

Dikw. Alu. Ø 80 mm wit



5201400	Dikw. Aluminium Ø 80 mm pijp L= 250 mm WIT	16,30	A
5201410	Dikw. Aluminium Ø 80 mm pijp L= 500 mm WIT	23,90	A
5201420	Dikw. Aluminium Ø 80 mm pijp L= 1000 mm WIT	35,60	A
5201440	Dikw. Aluminium Ø 80 mm bocht 87° WIT	27,30	A
5201450	Dikw. Aluminium Ø 80 mm bocht 43° WIT	25,50	A

Dikw. Alu. Ø 100 mm



5200600	Dikw. Aluminium Ø 100 mm pijp L= 250 mm	23,70	A
5200610	Dikw. Aluminium Ø 100 mm pijp L= 500 mm	34,40	A
5200620	Dikw. Aluminium Ø 100 mm pijp L= 1000 mm	57,00	A
5200640	Dikw. Aluminium Ø 100 mm pijp L= 2000 mm	102,50	A
5200650	Dikw. Aluminium Ø 100 mm pijp L= 3000 mm	147,00	A
5200670	Dikw. Aluminium Ø 100 mm bocht 90°	31,50	A
5200680	Dikw. Aluminium Ø 100 mm bocht 43°	29,60	A
5200690	Dikw. Aluminium Ø 100 mm lippenring	4,10	A
5200700	Dikw. Aluminium Ø 100 mm condensafvoer H/V	124,20	A
5201550	Dikw. Aluminium verloopstuk vergrotend Ø 90 - 100 mm	29,50	A
5201540	Dikw. Aluminium verloopstuk vergrotend Ø 100 - 110 mm	45,10	A
5201600	Dikw. Aluminium verloopstuk verkleinend Ø 100 - 80 mm	30,00	A
5201710	Aluminium Beugel Ø 100 mm moer M8	6,00	A





Dikw. Alu. Ø 110 mm



5200840	Dikw. Aluminium Ø 110 mm pijp L= 250 mm	30,30	A
5200830	Dikw. Aluminium Ø 110 mm pijp L= 500 mm	41,70	A
5200820	Dikw. Aluminium Ø 110 mm pijp L= 1000 mm	64,30	A
5200850	Dikw. Aluminium Ø 110 mm segmentbocht 90°	93,70	A
5200860	Dikw. Aluminium Ø 110 mm segmentbocht 45°	72,00	A
5200870	Dikw. Aluminium Ø 110 mm Lippenring	6,20	A
5201570	Dikw. Aluminium verloopstuk vergrotend Ø 110 - 130 mm	48,60	A
5201580	Dikw. Aluminium verloopstuk verkleinend Ø 110 - 100 mm	45,10	A
5201720	Aluminium Beugel Ø 110 mm moer M8	6,20	A

ROOKGASKANALEN

CV Aansluitmateriaal Dikwandig Aluminium

	Artikelnr.	Omschrijving	Brutoprijs	Krt.G
Dikw. Alu. Ø 130 mm 	5200900	Dikw. Aluminium Ø 130 mm pijp L= 250 mm	35,90	A
	5200910	Dikw. Aluminium Ø 130 mm pijp L= 500 mm	48,40	A
	5200920	Dikw. Aluminium Ø 130 mm pijp L= 1000 mm	72,80	A
	5200930	Dikw. Aluminium Ø 130 mm pijp L= 2000 mm	122,50	A
	5200950	Dikw. Aluminium Ø 130 mm segmentbocht 87-90°	104,80	A
	5200960	Dikw. Aluminium Ø 130 mm segmentbocht 45°	76,00	A
	5200970	Dikw. Aluminium Ø 130 mm Lippenring	7,10	A
	5201590	Dikw. Aluminium verloopstuk vergrotend Ø 130 - 150 mm	52,40	A
	5201730	Aluminium Beugel Ø 130 mm moer M8	6,90	A
Dikw. Alu. Ø 150 mm 	5201000	Dikw. Aluminium Ø 150 mm pijp L= 250 mm	43,20	A
	5201010	Dikw. Aluminium Ø 150 mm pijp L= 500 mm	58,60	A
	5201020	Dikw. Aluminium Ø 150 mm pijp L= 1000 mm	88,80	A
	5201050	Dikw. Aluminium Ø 150 mm segmentbocht 87-90°	117,50	A
	5201060	Dikw. Aluminium Ø 150 mm segmentbocht 45°	81,80	A
	5201040	Dikw. Aluminium Ø 150 mm lippenring	7,30	A
	5201740	Aluminium Beugel Ø 150 mm moer M8	7,20	A
	Dikw. Alu. Ø 180 mm 	5201130	Dikw. Aluminium Ø 180 mm pijp L= 500 mm	68,40
5201100		Dikw. Aluminium Ø 180 mm pijp L= 1000 mm	111,80	A
5201140		Dikw. Aluminium Ø 180 mm pijp L= 2000 mm	212,40	A
5201110		Dikw. Aluminium Ø 180 mm segmentbocht 87-90°	135,00	A
5201120		Dikw. Aluminium Ø 180 mm segmentbocht 45°	104,20	A
5201750		Aluminium Beugel Ø 180 mm moer M8	8,60	A
Dikw. Alu. Ø 200 mm 	5201230	Dikw. Aluminium Ø 200 mm pijp L= 500 mm	74,70	A
	5201200	Dikw. Aluminium Ø 200 mm pijp L= 1000 mm	120,80	A
	5201240	Dikw. Aluminium Ø 200 mm pijp L= 2000 mm	229,00	A
	5201210	Dikw. Aluminium Ø 200 mm segmentbocht 87-90°	169,20	A
	5201220	Dikw. Aluminium Ø 200 mm segmentbocht 45°	129,60	A
	5201760	Aluminium Beugel Ø 200 mm moer M8	10,50	A
Dikw. Alu. Ø 250 mm 	5201330	Dikw. Aluminium Ø 250 mm pijp L= 500 mm	76,50	A
	5201300	Dikw. Aluminium Ø 250 mm pijp L= 1000 mm	146,60	A
	5201310	Dikw. Aluminium Ø 250 mm segmentbocht 87-90°	310,70	A
	5201320	Dikw. Aluminium Ø 250 mm segmentbocht 45°	241,40	A
	5201770	Aluminium Beugel Ø 250 mm moer M8	12,40	A



ROOKGASKANALEN

CV Aansluitmateriaal Concentrisch Twinsafe PP

	Artikelnr.	Omschrijving	Brutoprijs	Krt.G
Concentrisch Ø 60/100 Twinsafe PP 	5801100	Twinsafe Concentrisch Ø 60/100 mm pijp L = 250 mm	19,20	A
	5801110	Twinsafe Concentrisch Ø 60/100mm pijp L = 500 mm	26,20	A
	5801120	Twinsafe Concentrisch Ø 60/100mm pijp L = 1000 mm	36,20	A
	5801130	Twinsafe Concentrisch Ø 60/100mm pijp L = 2000 mm	65,40	A
	5801140	Twinsafe Concentrisch Ø 60/100mm paspijp	35,20	A
	5801150	Twinsafe Concentrisch Ø 60/100mm bocht 90°	25,60	A
	5801160	Twinsafe Concentrisch Ø 60/100mm bocht 45°	25,30	A
	5801190	Twinsafe Concentrisch Ø 60/100mm condensafvoer	70,50	A
	5801165	Twinsafe Concentrisch verloop Ø 60/100 > Ø 80/125	70,20	A

Concentrisch Ø 80/125 Twinsafe PP 	5801000	Twinsafe Concentrisch Ø 80/125mm pijp L=250 mm	30,10	A
	5801010	Twinsafe Concentrisch Ø 80/125mm pijp L=500 mm	37,80	A
	5801020	Twinsafe Concentrisch Ø 80/125mm pijp L=1000 mm	49,30	A
	5801030	Twinsafe Concentrisch Ø 80/125mm pijp L=2000 mm	92,10	A
	5801040	Twinsafe Concentrisch Ø 80/125mm paspijp	54,80	A
	5801050	Twinsafe Concentrisch Ø 80/125mm bocht 90°	37,80	A
	5801060	Twinsafe Concentrisch Ø 80/125mm bocht 45°	35,00	A
	5801090	Twinsafe Concentrisch Ø 80/125mm condensafvoer	81,10	A
	5801065	Twinsafe Concentrisch verloop Ø 80/125 > Ø 100/150	66,90	A

Concentrisch Ø 100/150 Twinsafe PP 	5801210	Twinsafe Concentrisch Ø 100/150 pijp L=250 mm	51,70	A
	5801220	Twinsafe Concentrisch Ø 100/150 pijp L=500 mm	59,30	A
	5801230	Twinsafe Concentrisch Ø 100/150 pijp L=1000 mm	78,60	A
	5801240	Twinsafe Concentrisch Ø 100/150 pijp L=2000 mm	124,70	A
	5801250	Twinsafe Concentrisch Ø 100/150 paspijp	59,30	A
	5801260	Twinsafe Concentrisch Ø 100/150 bocht 90°	79,60	A
	5801270	Twinsafe Concentrisch Ø 100/150 bocht 45°	68,10	A
	5801280	Twinsafe Concentrisch Ø 100/150 condensafvoer	101,80	A



ROOKGASKANALEN

CV Aansluitmateriaal Dak- en muurdoorvoeren en Accessoires

Dakdoorvoeren

HR Ketels



Artikelnr.	Omschrijving	Brutoprijs	Krt.G
5800000	Econext HR DDV 80/80 PP met broekstuk (Cox Geelen)	125,40	A
5800005	Econext HR DDV Kort 80/125 PP RG pijp (Cox Geelen)	76,50	A
5800060	Rolux 5G HR DDV 80/80 PP met broekstuk (Ubbink)	93,20	A
5800070	Rolux 5G HR DDV 80/80 Alu met broekstuk (Ubbink)	99,60	A
5800130	Skyline 3000 PP 60/100 met broekstuk (Burgerhout)	134,70	A
5800135	Skyline 3000 PP 80/125 met broekstuk (Burgehout)	110,50	A
5800140	Skyline 3000 ALU 80/125 met broekstuk (Burgerhout)	122,50	A
5800145	Skyline 3000 PP 100/150 met broekstuk (Burgerhout)	216,30	A

Accessoires

Dakdoorvoeren



5800010	Universele loodpan verstelbaar standaard 25°-50°	56,70	A
3200130	Elistipan verstelbaar 500 x 625 mm	63,90	A
3200020	Universele Ubiflex pan met glijschaal 15°-55°	55,20	A
5800020	Glijschaal tbv Uni (lood)pan Ø 139 mm (tbv 80/80)	8,20	A
5800025	Glijschaal tbv Uni (lood)pan Ø 168 mm (tbv 100/100)	17,70	A
5800050	Aluminium plaklaaf platdak Ø 139 mm (tbv 80/80)	25,80	A
5800051	Aluminium plaklaaf platdak Ø 168 mm (tbv 100/100)	30,30	A
5800015	Pan Sneldek zwart 1 pans	35,90	A
5800017	Pan Neroma zwart 1 pans	35,90	A

Muurdoorvoeren HR



5800030	Econext muurdoorvoer 80/80 + broekstuk PPs	119,00	A
5800040	Muurdoorvoer dubbelpijps 80/80 Dikw.Alu.	113,90	A
5800042	Muurdoorvoer dubbelpijps 100/100 Dikw.Alu.	127,80	A
5800035	BUHO muurdoorvoer 80/80 Alu + adapter wit metaal	142,90	A
5800036	BUHO muurdoorvoer 80/80 PP RG pijp + adapter	106,30	A

Schoorsteentop



5800170	Skyline HR Schoorsteentop PP Ø 80 mm (140 mm)	62,40	A
5880175	Skyline HR Grespot aansluitstuk 155 / 138 mm	28,10	A
5880180	Skyline HR Schoorsteentop PP Ø 100 mm (158 mm)	89,30	A
5880190	BH VR Schoorsteentop Alu. Ø 80 mm	95,90	A

Accessoires



5800080	Dampdichte kunststof flexibele manchet	22,00	A
5800085	Kunststof broekstuk Ø 80/80 > 125mm	41,60	A
5800090	Kunststof broekstuk Ø 100/100 > 150mm	64,80	A
5800095	Universele adapter Slim Ø 80/80 > 125mm staal	53,90	A

EPDM Manchet



5800120	EPDM DDV manchet Ø 110 - 200 mm Flexub	119,50	A
5800125	EPDM DDV manchet Ø 150 - 315 mm + Montagekit	172,10	A
5800128	EPDM DDV Slabbe Ø 80 - 130 mm compleet	134,50	A
5800127	EPDM DDV Slabbe Ø 130 - 200 mm compleet	134,50	A
5800129	EPDM DDV Slabbe Ø 250 - 300 mm compleet	148,00	A





“ Met Burgerhout
weet je dat je met
kwaliteit werkt ”

Innovatieve oplossingen

voor rookgasafvoer- en
luchtdistributiesystemen



Burgerhout®

INNOVATIVE
PARTNER

burgerhout.nl

HOOFDSTUK 2

Rookgaskanalen RVS Dubbelwandig

Omschrijving	Pagina
Dubbelwandig RVS Geïsoleerd Kachel/open haardkanaal Ø 80 / 130 mm	16
Dubbelwandig RVS Geïsoleerd Kachel/open haardkanaal Ø 100 / 150 mm	17
Dubbelwandig RVS Geïsoleerd Kachel/open haardkanaal Ø 130 / 180 mm	18
Dubbelwandig RVS Geïsoleerd Kachel/open haardkanaal Ø 150 / 200 mm	19
Dubbelwandig RVS Geïsoleerd Kachel/open haardkanaal Ø 180 / 230 mm	21
Dubbelwandig RVS Geïsoleerd Kachel/open haardkanaal Ø 200 / 250 mm	22
Dubbelwandig RVS Geïsoleerd Kachel/open haardkanaal Ø 250 / 300 mm	23
Dubbelwandig RVS Geïsoleerd Kachel/open haardkanaal Ø 300 / 350 mm	24
Dubbelwandig RVS Geïsoleerd Kachel/open haardkanaal Ø 350 / 400 mm	25
Dubbelwandig RVS Geïsoleerd Kachel/open haardkanaal standaard ZWART	26
Dubbelwandig RVS Met luchtspouw en lipring Ø 80 / 95 mm - Ø 100 / 115 mm	27
Dubbelwandig RVS Met luchtspouw en lipring Ø 130 / 145 mm - Ø 150 / 165 mm	28
Dubbelwandig RVS Met luchtspouw en lipring Ø 180 / 195 mm - Ø 200 / 215 mm	29
Dubbelwandig RVS Met luchtspouw en lipring Ø 250 / 265 mm	30



ROOKGASKANALEN

Dubbelwandig Kachel / Open Haardkanaal Schiedel ICS 25 Geïsoleerd

Ø 80 /130 mm
Geïsoleerd



Artikelnr.	Omschrijving	Brutoprijs	Krt.G
1100000	ICS 25 RVS Ø 80/130 mm pijp L = 1000 mm	107,10	A
1100100	ICS 25 RVS Ø 80/130 mm pijp L = 500 mm	70,90	A
1100200	ICS 25 RVS Ø 80/130 mm pijp L = 250 mm	61,80	A
1104400	ICS 25 RVS Ø 80/130 mm paspijp 190-250 mm	104,40	A
1100300	ICS 25 RVS Ø 80/130 mm paspijp 275-365 mm	102,90	A
1100305	ICS 25 RVS Ø 80/130 mm paspijp 375-585 mm	136,40	A
1100400	ICS 25 RVS Ø 80/130 mm bocht 90°	151,30	A
1100500	ICS 25 RVS Ø 80/130 mm bocht 45°	100,90	A
1100600	ICS 25 RVS Ø 80/130 mm bocht 30°	100,90	A
1100700	ICS 25 RVS Ø 80/130 mm bocht 15°	100,90	A
1100800	ICS 25 RVS Ø 80/130 mm T-stuk 90°	145,30	A
1100900	ICS 25 RVS Ø 80/130 mm T-stuk 45°	176,10	A
1101000	ICS 25 RVS Ø 80/130 mm inspectie T-stuk 90°	205,70	A
1101400	ICS 25 RVS Ø 80/130 mm deksel voor T-stuk	64,80	A
1101500	ICS 25 RVS Ø 80/130 mm dop met aftap	53,20	A
1101106	ICS 25 RVS Ø 80/130 mm onderverloop DW/EW blank	65,50	A
1101105	ICS 25 RVS Ø 80/130 mm onderverloop DW/EW zwart	81,30	A
1101200	ICS 25 RVS Ø 80/130 mm stormkraag	32,20	A
1101610	ICS 25 RVS Ø 80/130 mm trekkap zonder gaas	99,30	A
1101710	ICS 25 RVS Ø 80/130 mm trekkap met gaas	107,90	A
1101900	ICS 25 RVS Ø 80/130 mm conische top	50,00	A
1102000	ICS 25 RVS Ø 80/130 mm bovenverloop EW/DW	47,40	A
1102100	ICS 25 RVS Ø 80/130 mm muurbeugel vast	36,30	A
1102101	ICS 25 RVS Ø 80/130 mm muurbeugel verstelbaar	40,10	A
1102105	ICS 25 RVS muurbeugel verlenging tot 420 mm (excl. Beugel)	74,20	A
1102106	ICS 25 RVS muurbeugel verlenging tot 250 mm (excl. Beugel)	45,60	A
1102107	ICS 25 RVS muurbeugel verlenging tot 150 mm (excl. Beugel)	35,10	A
1102200	ICS 25 RVS Ø 80/130 mm dakplaat plattendak 0°	74,10	A
1102205	ICS 25 RVS Ø 80/130 mm dakplaat hellenddak 5-30°	92,50	A
1102500	ICS 25 RVS Ø 80/130 mm loodslab 20°-45°	199,50	A
1102600	ICS 25 RVS Ø 80/130 mm loodslab 45°-60°	215,00	A
5800120	EPDM DDV Manchet Ø 110 - 200 mm Flexub	119,50	A
5800127	EPDM DDV Slabbe Ø 130 - 200 mm compleet	131,70	A
1102300	ICS 25 RVS Ø 80/130 mm verdiepingsteunplaat	36,00	A
1102400	ICS 25 RVS Ø 80/130 mm daksteunbeugel	24,20	A
1102700	ICS 25 RVS Ø 80/130 mm tuidraadbeugel	20,80	A
1102900	ICS 25 RVS Ø 80/130 mm bodembevestigingsplaat DW/DW	92,40	A
1101300	ICS 25 RVS Ø 80/130 mm bodembevestigingsplaat DW/EW	90,90	A
1103000	ICS 25 RVS Ø 80/130 mm brede klemband	16,80	A
1103200	ICS 25 RVS DW verloop Ø 80/130 mm - Ø 100/150 mm	130,30	A
1103600	ICS 25 RVS Ø 80/130 mm rozet 85 mm	25,40	A
1103100	ICS 25 RVS Ø 80/130 mm set centreerplaten	20,90	A

Standaard geleverd met klemband

SCHIEDEL



ROOKGASKANALEN

Dubbelwandig Kachel / Open Haardkanaal Schiedel ICS 25 Geïsoleerd

Ø 100 /150 mm
Geïsoleerd



Artikelnr.	Omschrijving	Brutoprijs	Krt.G
1100010	ICS 25 RVS Ø 100/150 mm pijp L = 1000 mm	115,90	A
1100110	ICS 25 RVS Ø 100/150 mm pijp L = 500 mm	74,50	A
1100210	ICS 25 RVS Ø 100/150 mm pijp L = 250 mm	66,00	A
1104410	ICS 25 RVS Ø 100/150 mm paspijp 190-250 mm	108,90	A
1100310	ICS 25 RVS Ø 100/150 mm paspijp 275-365 mm	107,00	A
1100315	ICS 25 RVS Ø 100/150 mm paspijp 375-585 mm	144,70	A
1100410	ICS 25 RVS Ø 100/150 mm bocht 90°	162,60	A
1100510	ICS 25 RVS Ø 100/150 mm bocht 45°	102,90	A
1100610	ICS 25 RVS Ø 100/150 mm bocht 30°	102,90	A
1100710	ICS 25 RVS Ø 100/150 mm bocht 15°	102,90	A
1100810	ICS 25 RVS Ø 100/150 mm T-stuk 90°	151,50	A
1100910	ICS 25 RVS Ø 100/150 mm T-stuk 45°	205,70	A
1101010	ICS 25 RVS Ø 100/150 mm inspectie T stuk 90°	218,20	A
1101410	ICS 25 RVS Ø 100/150 mm deksel voor T-stuk	70,10	A
1101510	ICS 25 RVS Ø 100/150 mm dop met aftap	55,90	A
1101116	ICS 25 RVS Ø 100/150 mm onderverloop DW/EW blank	69,20	A
1101115	ICS 25 RVS Ø 100/150 mm onderverloop DW/EW zwart	85,00	A
1101210	ICS 25 RVS Ø 100/150 mm stormkraag	34,60	A
1101615	ICS 25 RVS Ø 100/150 mm trekkap zonder gaas	100,40	A
1101715	ICS 25 RVS Ø 100/150 mm trekkap met gaas	109,20	A
1101910	ICS 25 RVS Ø 100/150 mm conische top	51,70	A
1102010	ICS 25 RVS Ø 100/150 mm bovenverloop EW/DW	58,10	A
1102110	ICS 25 RVS Ø 100/150 mm muurbeugel vast	36,30	A
1102111	ICS 25 RVS Ø 100/150 mm muurbeugel verstelbaar	41,20	A
1102105	ICS 25 RVS muurbeugel verlenging tot 420 mm (excl. Beugel)	74,20	A
1102106	ICS 25 RVS muurbeugel verlenging tot 250 mm (excl. Beugel)	45,60	A
1102107	ICS 25 RVS muurbeugel verlenging tot 150 mm (excl. Beugel)	35,10	A
1102210	ICS 25 RVS Ø 100/150 mm dakplaat platdak 0°	74,10	A
1102215	ICS 25 RVS Ø 100/150 mm dakplaat hellenddak 5-30°	90,50	A
1102510	ICS 25 RVS Ø 100/150 mm loodslab 20°-45°	199,50	A
1102610	ICS 25 RVS Ø 100/150 mm loodslab 45°-60°	215,00	A
5800120	EPDM DDV Manchet Ø 110 - 200 mm Flexub	119,50	A
5800127	EPDM DDV Slabbe Ø 130 - 200 mm compleet	131,70	A
1102310	ICS 25 RVS Ø 100/150 mm verdiepingsteunplaat	43,30	A
1102410	ICS 25 RVS Ø 100/150 mm daksteunbeugel	24,20	A
1102710	ICS 25 RVS Ø 100/150 mm tuidraadbeugel	22,70	A
1102910	ICS 25 RVS Ø 100/150 mm bodembevestigingsplaat DW/DW	102,00	A
1101310	ICS 25 RVS Ø 100/150 mm bodembevestigingsplaat DW/EW	101,70	A
1103010	ICS 25 RVS Ø 100/150 mm brede klemband	17,60	A
1103210	ICS 25 RVS DW verloop Ø 100/150 mm - Ø 130/180 mm	131,90	A
1103610	ICS 25 RVS Ø 100/150 mm rozet 85 mm	26,00	A
1103910	ICS 25 RVS Ø 100/150 mm afsluitplaat vierkant 120 mm	17,30	A
1103110	ICS 25 RVS Ø 100/150 mm set centreerplaten	21,20	A

Standaard geleverd met klemband

SCHIEDEL



ROOKGASKANALEN

Dubbelwandig Kachel / Open Haardkanaal Schiedel ICS 25 Geïsoleerd

Ø 130 /180 mm
Geïsoleerd



Artikelnr.	Omschrijving	Brutoprijs	Krt.G
1100020	ICS 25 RVS Ø 130/180 mm pijp L = 1000 mm	126,60	A
1100120	ICS 25 RVS Ø 130/180 mm pijp L = 500 mm	77,70	A
1100220	ICS 25 RVS Ø 130/180 mm pijp L = 250 mm	69,80	A
1104420	ICS 25 RVS Ø 130/180 mm paspijp 190-250 mm	104,90	A
1100320	ICS 25 RVS Ø 130/180 mm paspijp 275-365 mm	120,60	A
1100325	ICS 25 RVS Ø 130/180 mm paspijp 375-585 mm	158,10	A
1100420	ICS 25 RVS Ø 130/180 mm bocht 90°	183,00	A
1100520	ICS 25 RVS Ø 130/180 mm bocht 45°	109,10	A
1100620	ICS 25 RVS Ø 130/180 mm bocht 30°	109,10	A
1100720	ICS 25 RVS Ø 130/180 mm bocht 15°	109,10	A
1100820	ICS 25 RVS Ø 130/180 mm T-stuk 90°	166,90	A
1100920	ICS 25 RVS Ø 130/180 mm T-stuk 45°	226,20	A
1101020	ICS 25 RVS Ø 130/180 mm inspectie T-stuk 90°	248,90	A
1101420	ICS 25 RVS Ø 130/180 mm deksel voor T-stuk	85,60	A
1101520	ICS 25 RVS Ø 130/180 mm dop met aftap	60,50	A
1101128	ICS 25 RVS Ø 130/180 mm onderverl. DW/EW > Ø 130 blank	72,80	A
1011127	ICS 25 RVS Ø 130/180 mm onderverl. DW/EW > Ø 130 zwart	89,30	A
1101125	ICS 25 RVS Ø 130/180 mm onderverl. DW/EW > Ø 125 zwart	93,70	A
1101126	ICS 25 RVS Ø 130/180 mm onderverl. DW/EW > Ø 125 blank	82,60	A
1101220	ICS 25 RVS Ø 130/180 mm stormkraag	37,60	A
1101620	ICS 25 RVS Ø 130/180 mm trekkap zonder gaas	78,30	A
1101720	ICS 25 RVS Ø 130/180 mm trekkap met gaas	87,10	A
1103520	ICS 25 RVS Ø 130/180 mm trekkap met veegluik	126,00	A
1101920	ICS 25 RVS Ø 130/180 mm conische top	51,40	A
1102020	ICS 25 RVS Ø 130/180 mm bovenverloop EW/DW	61,30	A
1102120	ICS 25 RVS Ø 130/180 mm muurbeugel vast	37,70	A
1102121	ICS 25 RVS Ø 130/180 mm muurbeugel verstelbaar	42,80	A
1102105	ICS 25 RVS muurbeugel verlenging tot 420 mm (excl. Beugel)	74,20	A
1102106	ICS 25 RVS muurbeugel verlenging tot 250 mm (excl. Beugel)	45,60	A
1102107	ICS 25 RVS muurbeugel verlenging tot 150 mm (excl. Beugel)	35,10	A
1102115	ICS 25 RVS Ø 130/180 mm omkokeringsbeugel	53,10	A
1102220	ICS 25 RVS Ø 130/180 mm dakplaat platdak 0°	88,80	A
1102225	ICS 25 RVS Ø 130/180 mm dakplaat hellend 5°-30°	92,50	A
1102520	ICS 25 RVS Ø 130/180 mm loodslab 20°-45°	201,90	A
1102620	ICS 25 RVS Ø 130/180 mm loodslab 45°-60°	218,70	A
5800120	EPDM DDV Manchet Ø 110 - 200 mm Flexub	119,50	A
5800127	EPDM DDV Slabbe Ø 130 - 200 mm compleet	131,70	A
1102320	ICS 25 RVS Ø 130/180 mm verdiepingsteunplaat	55,60	A
1102420	ICS 25 RVS Ø 130/180 mm daksteunbeugel	25,80	A
1102720	ICS 25 RVS Ø 130/180 mm tuidraadbeugel	23,50	A
1102920	ICS 25 RVS Ø 130/180 mm bodembevestigingsplaat DW/DW	114,90	A
1101320	ICS 25 RVS Ø 130/180 mm bodembevestigingsplaat DW/EW	120,60	A
1103020	ICS 25 RVS Ø 130/180 mm brede klemband	18,60	A
1103230	ICS 25 RVS DW verloop Ø 130/180 mm - Ø 150/200 mm	140,10	A
1103620	ICS 25 RVS Ø 130/180 mm rozet 85 mm	27,10	A
1103920	ICS 25 RVS Ø 130/180 mm afsluitplaat vierkant 120 mm	18,70	A
1102925	ICS 25 RVS Ø 130/180 mm set centeerplaten	42,00	A

Standaard geleverd met klemband



SCHIEDEL



ROOKGASKANALEN

Dubbelwandig Kachel / Open Haardkanaal Schiedel ICS 25 Geïsoleerd

Ø 150 /200 mm
Geïsoleerd



Artikelnr.	Omschrijving	Brutoprijs	Krt.G
1100030	ICS 25 RVS Ø 150/200 mm pijp L = 1000 mm	137,50	A
1100130	ICS 25 RVS Ø 150/200 mm pijp L = 500 mm	86,50	A
1100230	ICS 25 RVS Ø 150/200 mm pijp L = 250 mm	77,70	A
1104430	ICS 25 RVS Ø 150/200 mm paspijp 190-250 mm	109,00	A
1100330	ICS 25 RVS Ø 150/200 mm paspijp 275-365 mm	127,60	A
1100335	ICS 25 RVS Ø 150/200 mm paspijp 375-585 mm	169,70	A
1100430	ICS 25 RVS Ø 150/200 mm bocht 90°	199,60	A
1100530	ICS 25 RVS Ø 150/200 mm bocht 45°	116,20	A
1100630	ICS 25 RVS Ø 150/200 mm bocht 30°	116,20	A
1100730	ICS 25 RVS Ø 150/200 mm bocht 15°	116,20	A
1100830	ICS 25 RVS Ø 150/200 mm T-stuk 90°	181,80	A
1100930	ICS 25 RVS Ø 150/200 mm T-stuk 45°	240,70	A
1101030	ICS 25 RVS Ø 150/200 mm inspectie T stuk 90°	256,10	A
1101430	ICS 25 RVS Ø 150/200 mm deksel voor T-stuk	93,80	A
1101530	ICS 25 RVS Ø 150/200 mm dop met aftap	70,00	A
1101135	ICS 25 RVS Ø 150/200 mm onderverloop DW/EW zwart	96,90	A
1101136	ICS 25 RVS Ø 150/200 mm onderverloop DW/EW Blank	84,80	A
1101230	ICS 25 RVS Ø 150/200 mm stormkraag	41,10	A
1101630	ICS 25 RVS Ø 150/200 mm trekkap zonder gaas	93,10	A
1101730	ICS 25 RVS Ø 150/200 mm trekkap met gaas	104,50	A
1103530	ICS 25 RVS Ø 150/200 mm trekkap met veegluik	137,00	A
1101930	ICS 25 RVS Ø 150/200 mm conische top	52,60	A
1102030	ICS 25 RVS Ø 150/200 mm bovenverloop EW/DW	70,00	A
1102130	ICS 25 RVS Ø 150/200 mm muurbeugel vast	37,90	A
1102131	ICS 25 RVS Ø 150/200 mm muurbeugel verstelbaar	43,30	A
1102105	ICS 25 RVS muurbeugel verlenging tot 420 mm (excl. Beugel)	74,20	A
1102106	ICS 25 RVS muurbeugel verlenging tot 250 mm (excl. Beugel)	45,60	A
1102107	ICS 25 RVS muurbeugel verlenging tot 150 mm (excl. Beugel)	35,10	A
1102135	ICS 25 RVS Ø 150/200 mm omkokeringsbeugel	55,70	A
1102230	ICS 25 RVS Ø 150/200 mm dakplaat platdak 0°	74,10	A
1102235	ICS 25 RVS Ø 150/200 mm dakplaat hellenddak 5-30°	92,50	A
1102530	ICS 25 RVS Ø 150/200 mm loodslab 20°-45°	201,90	A
1102630	ICS 25 RVS Ø 150/200 mm loodslab 45°-60°	230,40	A
1102635	ICS 25 RVS Ø 150/200 mm nok loodslab 20°-45°	263,60	A
5800120	EPDM DDV Manchet Ø 110 - 200 mm Flexub	119,50	A
5800127	EPDM DDV Slabbe Ø 130 - 200 mm compleet	131,70	A
1102330	ICS 25 RVS Ø 150/200 mm verdiepingsteunplaat	38,20	A
1102430	ICS 25 RVS Ø 150/200 mm daksteunbeugel	26,40	A
1102730	ICS 25 RVS Ø 150/200 mm tuidraadbeugel	24,80	A
1102930	ICS 25 RVS Ø 150/200 mm bodembevestigingsplaat DW/DW	172,90	A
1101340	ICS 25 RVS Ø 150/200 mm bodembevestigingsplaat DW/EW	162,00	A
1103030	ICS 25 RVS Ø 150/200 mm brede klemband	19,40	A
1103230	ICS 25 RVS DW verloop Ø 150/200 mm - Ø 180/230 mm	140,10	A
1103630	ICS 25 RVS Ø 150/200 mm rozet 85 mm	27,90	A
1103930	ICS 25 RVS Ø 150/200 mm afsluitplaat vierkant 120 mm	19,70	A
1103130	ICS 25 RVS Ø 150/200 mm set centeerplaten	22,00	A

Standaard geleverd met klemband

SCHIEDEL



SCHIEDEL

ICS

SCHIEDEL
Heating, Venting, Living.



SCHIEDEL ICS

*HET MULTIFUNCTIONELE DUBBELWANDIGE
ROOKGASAFVOERSYSTEEM IN RVS*

ROOKGASKANALEN

Dubbelwandig Kachel / Open Haardkanaal Schiedel ICS 25 Geïsoleerd

Ø 180/230 mm
Geïsoleerd



Artikelnr.	Omschrijving	Brutoprijs	Krt.G
1100040	ICS 25 RVS Ø 180/230 mm pijp L = 1000 mm	154,20	A
1100140	ICS 25 RVS Ø 180/230 mm pijp L = 500 mm	94,30	A
1100240	ICS 25 RVS Ø 180/230 mm pijp L = 250 mm	86,50	A
1104440	ICS 25 RVS Ø 180/230 mm paspijp 190-250 mm	114,40	A
1100340	ICS 25 RVS Ø 180/230 mm paspijp 275-365 mm	145,10	A
1100345	ICS 25 RVS Ø 180/230 mm paspijp 375-585 mm	182,70	A
1100440	ICS 25 RVS Ø 180/230 mm bocht 90°	222,20	A
1100540	ICS 25 RVS Ø 180/230 mm bocht 45°	125,60	A
1100640	ICS 25 RVS Ø 180/230 mm bocht 30°	125,60	A
1100740	ICS 25 RVS Ø 180/230 mm bocht 15°	125,60	A
1100840	ICS 25 RVS Ø 180/230 mm T-stuk 90°	190,80	A
1100940	ICS 25 RVS Ø 180/230 mm T-stuk 45°	260,10	A
1101040	ICS 25 RVS Ø 180/230 mm inspectie T-stuk 90°	273,60	A
1101440	ICS 25 RVS Ø 180/230 mm deksel voor T-stuk	107,10	A
1101540	ICS 25 RVS Ø 180/230 mm dop met aftap	75,10	A
1101140	ICS 25 RVS Ø 180/230 mm onderverloop DW/EW blank	91,50	A
1101145	ICS 25 RVS Ø 180/230 mm onderverloop DW/EW zwart	101,40	A
1101240	ICS 25 RVS Ø 180/230 mm stormkraag	44,30	A
1101640	ICS 25 RVS Ø 180/230 mm trekkap zonder gaas	109,70	A
1101740	ICS 25 RVS Ø 180/230 mm trekkap met gaas	117,20	A
1103540	ICS 25 RVS Ø 180/230 mm trekkap met veegluik	147,30	A
1101940	ICS 25 RVS Ø 180/230 mm conische top	73,50	A
1102040	ICS 25 RVS Ø 180/230 mm bovenverloop EW/DW	78,30	A
1102140	ICS 25 RVS Ø 180/230 mm muurbeugel vast	41,40	A
1102141	ICS 25 RVS Ø 180/230 mm muurbeugel verstelbaar	44,90	A
1102105	ICS 25 RVS muurbeugel verlenging tot 420 mm (excl. Beugel)	74,20	A
1102106	ICS 25 RVS muurbeugel verlenging tot 250 mm (excl. Beugel)	45,60	A
1102107	ICS 25 RVS muurbeugel verlenging tot 150 mm (excl. Beugel)	35,10	A
1102240	ICS 25 RVS Ø 180/230 mm dakplaat platdak 0°	74,10	A
1102235	ICS 25 RVS Ø 180/230 mm dakplaat hellenddak 5-30°	92,60	A
1102540	ICS 25 RVS Ø 180/230 mm loodslab 20°-45°	251,40	A
1102640	ICS 25 RVS Ø 180/230 mm loodslab 45°-60°	278,30	A
5800125	EPDM DDV Manchet Ø 150 - 315 mm + Montagekit	177,30	A
5800127	EPDM DDV Slabbe Ø 130 - 200 mm compleet	131,70	A
1102340	ICS 25 RVS Ø 180/230 mm verdiepingsteunplaat	53,00	A
1102440	ICS 25 RVS Ø 180/230 mm daksteunbeugel	27,60	A
1102740	ICS 25 RVS Ø 180/230 mm tuidraadbeugel	27,90	A
1102940	ICS 25 RVS Ø 180/230 mm bodembevestigingsplaat DW>DW	161,80	A
1101330	ICS 25 RVS Ø 180/230 mm bodembevestigingsplaat DW/EW	139,90	A
1103040	ICS 25 RVS Ø 180/230 mm brede klemband	20,40	A
1103240	ICS 25 RVS DW verloop Ø 180/230 mm - Ø 200/250 mm	146,70	A
1103640	ICS 25 RVS Ø 180/230 mm rozet 85 mm	32,50	A
1103940	ICS 25 RVS Ø 180/230 mm afsluitplaat vierkant 120 mm	21,90	A
1103045	ICS 25 RVS Ø 180/230 mm set centreerplaten	41,20	A

Standaard geleverd met klemband

SCHIEDEL



ROOKGASKANALEN

Dubbelwandig Kachel / Open Haardkanaal Schiedel ICS 25 Geïsoleerd

Ø 200/250 mm
Geïsoleerd



Artikelnr.	Omschrijving	Brutoprijs	Krt.G
1100050	ICS 25 RVS Ø 200/250 mm pijp L = 1000 mm	174,60	A
1100150	ICS 25 RVS Ø 200/250 mm pijp L = 500 mm	115,80	A
1100250	ICS 25 RVS Ø 200/250 mm pijp L = 250 mm	99,30	A
1104450	ICS 25 RVS Ø 200/250 mm paspijp 190-250 mm	126,90	A
1100350	ICS 25 RVS Ø 200/250 mm paspijp 275-365 mm	163,70	A
1100355	ICS 25 RVS Ø 200/250 mm paspijp 375-585 mm	191,80	A
1100450	ICS 25 RVS Ø 200/250 mm bocht 90°	254,30	A
1100550	ICS 25 RVS Ø 200/250 mm bocht 45°	141,90	A
1100650	ICS 25 RVS Ø 200/250 mm bocht 30°	141,90	A
1100750	ICS 25 RVS Ø 200/250 mm bocht 15°	141,90	A
1100850	ICS 25 RVS Ø 200/250 mm T-stuk 90°	216,30	A
1100950	ICS 25 RVS Ø 200/250 mm T-stuk 45°	312,10	A
1101050	ICS 25 RVS Ø 200/250 mm inspectie T stuk 90°	286,90	A
1101450	ICS 25 RVS Ø 200/250 mm deksel voor T-stuk	124,50	A
1101550	ICS 25 RVS Ø 200/250 mm dop met aftap	83,10	A
1101155	ICS 25 RVS Ø 200/250 mm onderverloop DW/EW zwart	107,10	A
1101156	ICS 25 RVS Ø 200/250 mm onderverloop DW/EW blank	94,90	A
1101250	ICS 25 RVS Ø 200/250 mm stormkraag	46,90	A
1101650	ICS 25 RVS Ø 200/250 mm trekkap zonder gaas	119,40	A
1101750	ICS 25 RVS Ø 200/250 mm trekkap met gaas	130,80	A
1101950	ICS 25 RVS Ø 200/250 mm conische top	80,70	A
1102050	ICS 25 RVS Ø 200/250 mm bovenverloop EW/DW	85,50	A
1102150	ICS 25 RVS Ø 200/250 mm muurbeugel vast	41,40	A
1102155	ICS 25 RVS Ø 200/250 mm muurbeugel verstelbaar	49,00	A
1102105	ICS 25 RVS muurbeugel verlenging tot 420 mm (excl. Beugel)	74,20	A
1102106	ICS 25 RVS muurbeugel verlenging tot 250 mm (excl. Beugel)	45,60	A
1102107	ICS 25 RVS muurbeugel verlenging tot 150 mm (excl. Beugel)	35,10	A
1102145	ICS 25 RVS Ø 200/250 mm omkokeringsbeugel	60,50	A
1102250	ICS 25 RVS Ø 200/250 mm dakplaat platdak 0°	74,10	A
1102255	ICS 25 RVS Ø 200/250 mm dakplaat hellend 5-30°	92,50	A
1102550	ICS 25 RVS Ø 200/250 mm loodslab 20°-45°	251,40	A
1102650	ICS 25 RVS Ø 200/250 mm loodslab 45°-60°	278,30	A
5800125	EPDM DDV Manchet Ø 150 - 315 mm + Montagekit	177,30	A
5800129	EPDM DDV Slabbe Ø 250 - 300 mm compleet	145,30	A
1102350	ICS 25 RVS Ø 200/250 mm verdiepingsteunplaat	40,60	A
1102450	ICS 25 RVS Ø 200/250 mm daksteunbeugel	28,10	A
1102750	ICS 25 RVS Ø 200/250 mm tuidraadbeugel	29,80	A
1102950	ICS 25 RVS Ø 200/250 mm bodembevestigingsplaat DW/DW	189,70	A
1101350	ICS 25 RVS Ø 200/250 mm bodembevestigingsplaat DW/EW	178,20	A
1103050	ICS 25 RVS Ø 200/250 mm brede klemband	21,20	A
1103650	ICS 25 RVS Ø 200/250 mm rozet 85 mm	34,10	A
1103950	ICS 25 RVS Ø 200/250 mm afsluitplaat vierkant 120 mm	22,60	A
1103150	ICS 25 RVS Ø 200/250 mm set centreerplaten	23,40	A

Standaard geleverd met klemband

SCHIEDEL



ROOKGASKANALEN

Dubbelwandig Kachel / Open Haardkanaal Schiedel ICS 25 Geïsoleerd

Ø 250 /300 mm
Geïsoleerd



Artikelnr.	Omschrijving	Brutoprijs	Krt.G
1100060	ICS 25 RVS Ø 250/300 mm pijp L = 1000 mm	223,70	A
1100160	ICS 25 RVS Ø 250/300 mm pijp L = 500 mm	127,70	A
1100260	ICS 25 RVS Ø 250/300 mm pijp L = 250 mm	115,30	A
1104460	ICS 25 RVS Ø 250/300 mm paspijp 190-250 mm	132,10	A
1100360	ICS 25 RVS Ø 250/300 mm paspijp 275-365 mm	166,60	A
1100365	ICS 25 RVS Ø 250/300 mm paspijp 375-585 mm	218,00	A
1100460	ICS 25 RVS Ø 250/300 mm bocht 90°	286,00	A
1100560	ICS 25 RVS Ø 250/300 mm bocht 45°	173,90	A
1100660	ICS 25 RVS Ø 250/300 mm bocht 30°	164,60	A
1100760	ICS 25 RVS Ø 250/300 mm bocht 15°	164,60	A
1100860	ICS 25 RVS Ø 250/300 mm T-stuk 90°	282,80	A
1100960	ICS 25 RVS Ø 250/300 mm T-stuk 45°	361,30	A
1101060	ICS 25 RVS Ø 250/300 mm inspectie T-stuk 90°	298,30	A
1101460	ICS 25 RVS Ø 250/300 mm deksel voor T-stuk	140,00	A
1101560	ICS 25 RVS Ø 250/300 mm dop met aftap	98,10	A
1101160	ICS 25 RVS Ø 250/300 mm onderverloop DW/EW	102,70	A
1101260	ICS 25 RVS Ø 250/300 mm stormkraag	53,40	A
1101660	ICS 25 RVS Ø 250/300 mm trekkap zonder gaas	187,50	A
1101760	ICS 25 RVS Ø 250/300 mm trekkap met gaas	209,30	A
1103560	ICS 25 RVS Ø 250/300 mm trekkap met veegluik	210,20	A
1101960	ICS 25 RVS Ø 250/300 mm conische top	83,60	A
1102060	ICS 25 RVS Ø 250/300 mm bovenverloop EW/DW	93,80	A
1102160	ICS 25 RVS Ø 250/300 mm muurbeugel vast	46,10	A
1102105	ICS 25 RVS muurbeugel verlenging tot 420 mm (excl. Beugel)	74,20	A
1102106	ICS 25 RVS muurbeugel verlenging tot 250 mm (excl. Beugel)	45,60	A
1102107	ICS 25 RVS muurbeugel verlenging tot 150 mm (excl. Beugel)	35,10	A
1102260	ICS 25 RVS Ø 250/300 mm dakplaat platdak 0°	99,20	A
1102275	ICS 25 RVS Ø 250/300 mm dakplaat hellend 5-30°	107,60	A
1102560	ICS 25 RVS Ø 250/300 mm loodslab 20°-45°	249,10	A
1102660	ICS 25 RVS Ø 250/300 mm loodslab 45°-60°	284,60	A
5800125	EPDM DDV Manchet Ø 150 - 315 mm + Montagekit	177,30	A
5800129	EPDM DDV Slabbe Ø 250 - 300 mm compleet	145,30	A
1102360	ICS 25 RVS Ø 250/300 mm verdiepingsteunplaat	41,60	A
1102460	ICS 25 RVS Ø 250/300 mm daksteunbeugel	29,90	A
1102760	ICS 25 RVS Ø 250/300 mm tuidraadbeugel	32,10	A
1102960	ICS 25 RVS Ø 250/300 mm bodembevestigingsplaat DW/DW	218,60	A
1101360	ICS 25 RVS Ø 250/300 mm bodembevestigingsplaat DW/EW	20,90	A
1103060	ICS 25 RVS Ø 250/300 mm brede klemband	23,50	A
1103660	ICS 25 RVS Ø 250/3000 mm rozet 85 mm	38,30	A
1103960	ICS 25 RVS Ø 250/300 mm afsluitplaat vierkant 120 mm	25,60	A
1103065	ICS 25 RVS Ø 250/300 mm set centreerplaten	24,80	A

Standaard geleverd met klemband

SCHIEDEL



ROOKGASKANALEN

Dubbelwandig Kachel / Open Haardkanaal Schiedel ICS 25 Geïsoleerd

Ø 300 /350 mm
Geïsoleerd



Artikelnr.	Omschrijving	Brutoprijs	Krt.G
1100070	ICS 25 RVS Ø 300/350 mm pijp L = 1000 mm	257,20	A
1100170	ICS 25 RVS Ø 300/350 mm pijp L = 500 mm	158,40	A
1100270	ICS 25 RVS Ø 300/350 mm pijp L = 250 mm	127,70	A
1104470	ICS 25 RVS Ø 300/350 mm paspijp 190-250 mm	151,00	A
1100370	ICS 25 RVS Ø 300/350 mm paspijp 275-365 mm	188,30	A
1100375	ICS 25 RVS Ø 300/350 mm paspijp 375-585 mm	239,90	A
1100470	ICS 25 RVS Ø 300/350 mm bocht 90°	346,60	A
1100570	ICS 25 RVS Ø 300/350 mm bocht 45°	208,40	A
1100670	ICS 25 RVS Ø 300/350 mm bocht 30°	195,40	A
1100770	ICS 25 RVS Ø 300/350 mm bocht 15°	195,40	A
1100870	ICS 25 RVS Ø 300/350 mm T-stuk 90°	315,20	A
1100970	ICS 25 RVS Ø 300/350 mm T-stuk 45°	431,60	A
1101070	ICS 25 RVS Ø 300/350 mm inspectie T-stuk 90°	314,90	A
1101470	ICS 25 RVS Ø 300/350 mm deksel voor T-stuk	184,00	A
1101570	ICS 25 RVS Ø 300/350 mm dop met aftap	115,30	A
1101170	ICS 25 RVS Ø 300/350 mm onderverloop DW/EW blank	104,90	A
1101270	ICS 25 RVS Ø 300/350 mm stormkraag	58,00	A
1101670	ICS 25 RVS Ø 300/350 mm trekcap zonder gaas	207,10	A
1101770	ICS 25 RVS Ø 300/350 mm trekcap met gaas	256,50	A
1101970	ICS 25 RVS Ø 300/350 mm conische top	87,20	A
1102070	ICS 25 RVS Ø 300/350 mm bovenverloop EW/DW	101,00	A
1102170	ICS 25 RVS Ø 300/350 mm muurbeugel vast	50,80	A
1102105	ICS 25 RVS muurbeugel verlenging tot 420 mm (excl. Beugel)	74,20	A
1102106	ICS 25 RVS muurbeugel verlenging tot 250 mm (excl. Beugel)	45,60	A
1102107	ICS 25 RVS muurbeugel verlenging tot 150 mm (excl. Beugel)	35,10	A
1102270	ICS 25 RVS Ø 300/350 mm dakplaat platdak 0°	118,00	A
1102370	ICS 25 RVS Ø 300/350 mm verdiepingsteunplaat	57,50	A
1102470	ICS 25 RVS Ø 300/350 mm daksteunbeugel	31,70	A
1102570	ICS 25 RVS Ø 300/350 mm loodslab 20°-45°	348,70	A
1102670	ICS 25 RVS Ø 300/350 mm loodslab 45°-60°	395,80	A
1102770	ICS 25 RVS Ø 300/350 mm tuidraadbeugel	34,10	A
1102970	ICS 25 RVS Ø 300/350 mm bodembevestigingsplaat DW/DW	251,00	A
1101370	ICS 25 RVS Ø 300/350 mm bodembevestigingsplaat DW/EW	237,30	A
1103070	ICS 25 RVS Ø 300/350 mm brede klemband	25,40	A
1103670	ICS 25 RVS Ø 300/350 mm rozet 85 mm	42,30	A
1103970	ICS 25 RVS Ø 300/350 mm afsluitplaat vierkant 120 mm	30,00	A
1103165	ICS 25 RVS Ø 300/350 mm set centreerplaten	31,30	A

Standaard geleverd met klemband

SCHIEDEL



ROOKGASKANALEN

Dubbelwandig Kachel / Open Haardkanaal Schiedel ICS 25 Geïsoleerd

Ø 350 /400 mm
Geïsoleerd



Artikelnr.	Omschrijving	Brutoprijs	Krt.G
1100080	ICS 25 RVS Ø 350/400 mm pijp L = 1000 mm	287,90	A
1100180	ICS 25 RVS Ø 350/400 mm pijp L = 500 mm	208,80	A
1100280	ICS 25 RVS Ø 350/400 mm pijp L = 250 mm	150,30	A
1104480	ICS 25 RVS Ø 350/400 mm paspijp 190-250 mm	169,50	A
1100380	ICS 25 RVS Ø 350/400 mm paspijp 275-365 mm	196,50	A
1100385	ICS 25 RVS Ø 350/400 mm paspijp 375-585 mm	284,10	A
1100480	ICS 25 RVS Ø 350/400 mm bocht 90°	432,00	A
1100580	ICS 25 RVS Ø 350/400 mm bocht 45°	242,60	A
1100680	ICS 25 RVS Ø 350/400 mm bocht 30°	229,80	A
1100780	ICS 25 RVS Ø 350/400 mm bocht 15°	229,80	A
1100880	ICS 25 RVS Ø 350/400 mm T-stuk 90°	367,10	A
1100980	ICS 25 RVS Ø 350/400 mm T-stuk 45°	522,90	A
1101080	ICS 25 RVS Ø 350/400 mm inspectie T-stuk 90°	371,40	A
1101180	ICS 25 RVS Ø 350/400 mm onderverloop DW/EW blank	107,20	A
1101280	ICS 25 RVS Ø 350/400 mm stormkraag	63,30	A
1101480	ICS 25 RVS Ø 350/400 mm deksel voor T-stuk	196,50	A
1101580	ICS 25 RVS Ø 350/400 mm dop met aftap	122,50	A
1101680	ICS 25 RVS Ø 350/400 mm trekkap zonder gaas	251,80	A
1101780	ICS 25 RVS Ø 350/400 mm trekkap met gaas	370,70	A
1103580	ICS 25 RVS Ø 350/400 mm trekkap met veegluik	319,30	A
1101980	ICS 25 RVS Ø 350/400 mm conische top	120,60	A
1102080	ICS 25 RVS Ø 350/400 mm bovenverloop EW/DW	107,20	A
1102180	ICS 25 RVS Ø 350/400 mm muurbeugel vast	63,80	A
1102105	ICS 25 RVS muurbeugel verlenging tot 420 mm (excl. Beugel)	74,20	A
1102106	ICS 25 RVS muurbeugel verlenging tot 250 mm (excl. Beugel)	45,60	A
1102107	ICS 25 RVS muurbeugel verlenging tot 150 mm (excl. Beugel)	35,10	A
1102280	ICS 25 RVS Ø 350/400 mm dakplaat platdak 0°	141,70	A
1102580	ICS 25 RVS Ø 350/400 mm loodslab 20°-45°	435,80	A
1102680	ICS 25 RVS Ø 350/400 mm loodslab 45°-60°	493,30	A
1102380	ICS 25 RVS Ø 350/400 mm verdiepingsteunplaat	69,30	A
1102780	ICS 25 RVS Ø 350/400 mm tuidraadbeugel	38,30	A
1102980	ICS 25 RVS Ø 350/400 mm bodembevestigingsplaat DW/DW	273,20	A
1101380	ICS 25 RVS Ø 350/400 mm bodembevestigingsplaat DW/EW	261,00	A
1103980	ICS 25 RVS Ø 350/400 mm afsluitplaat vierkant 120 mm	33,60	A

Standaard geleverd met klemband
 Diameters 400 t/m 700 mm op aanvraag

SCHIEDEL



ROOKGASKANALEN

Dubbelwandig Kachel/OpenHaardkanaal Schiedel ICS 25 Geïsoleerd ZWART

Ø 80 /130 mm
Geïsoleerd
Zwart



Ø 100 /150 mm
Geïsoleerd
Zwart

Ø 130 /180 mm
Geïsoleerd
Zwart



Ø 150 /200 mm
Geïsoleerd
Zwart

Ø 180 /230 mm
Geïsoleerd
Zwart

Ø 200 /250 mm
Geïsoleerd
Zwart



Artikelnr.	Omschrijving	Brutoprijs	Krt.G
Z1100000	ICS 25 RVS Ø 80/130 mm pijp L = 1000 mm Zwart	133,90	A
Z1100100	ICS 25 RVS Ø 80/130 mm pijp L = 500 mm Zwart	88,70	A
Z1100200	ICS 25 RVS Ø 80/130 mm pijp L = 250 mm Zwart	77,30	A
Z1101200	ICS 25 RVS Ø 80/130 mm stormkraag Zwart	40,30	A
Z1101610	ICS 25 RVS Ø 80/130 mm Trekkap zonder gaas Zwart	124,20	A
Z1101710	ICS 25 RVS Ø 80/130 mm Trekkap met gaas Zwart	134,90	A
Z1102200	ICS 25 RVS Ø 80/130 mm dakplaat 0° Zwart	92,70	A
Z1102500	ICS 25 RVS Ø 80/130 mm loodslab 20°- 45° Zwart	249,40	A
Z1102600	ICS 25 RVS Ø 80/130 mm loodslab 45°- 60° Zwart	268,80	A
Z1100010	ICS 25 RVS Ø 100/150 mm pijp L = 1000 mm Zwart	144,90	A
Z1100110	ICS 25 RVS Ø 100/150 mm pijp L = 500 mm Zwart	93,20	A
Z1100210	ICS 25 RVS Ø 100/150 mm pijp L = 250 mm Zwart	82,50	A
Z1101210	ICS 25 RVS Ø 100/150 mm stormkraag Zwart	43,30	A
Z1101615	ICS 25 RVS Ø 100/150 mm Trekkap zonder gaas Zwart	125,50	A
Z1101715	ICS 25 RVS Ø 100/150 mm Trekkap met gaas Zwart	136,50	A
Z1102210	ICS 25 RVS Ø 100/150 mm dakplaat 0° Zwart	92,70	A
Z1102510	ICS 25 RVS Ø 100/150 mm loodslab 20°- 45° Zwart	249,40	A
Z1102610	ICS 25 RVS Ø 100/150 mm loodslab 45°- 60° Zwart	268,80	A
Z1100020	ICS 25 RVS Ø 130/180 mm pijp L = 1000 mm Zwart	158,30	A
Z1100120	ICS 25 RVS Ø 130/180 mm pijp L = 500 mm Zwart	97,20	A
Z1100220	ICS 25 RVS Ø 130/180 mm pijp L = 250 mm Zwart	87,30	A
Z1101220	ICS 25 RVS Ø 130/180 mm stormkraag Zwart	47,00	A
Z1101620	ICS 25 RVS Ø 130/180 mm Trekkap zonder gaas Zwart	97,90	A
Z1101720	ICS 25 RVS Ø 130/180 mm Trekkap met gaas Zwart	108,90	A
Z1102220	ICS 25 RVS Ø 130/180 mm dakplaat 0° Zwart	111,00	A
Z1102520	ICS 25 RVS Ø 130/180 mm loodslab 20°- 45° Zwart	252,40	A
Z1102620	ICS 25 RVS Ø 130/180 mm loodslab 45°- 60° Zwart	273,40	A
Z1100030	ICS 25 RVS Ø 150/200 mm pijp L = 1000 mm Zwart	171,90	A
Z1100130	ICS 25 RVS Ø 150/200 mm pijp L = 500 mm Zwart	108,20	A
Z1100230	ICS 25 RVS Ø 150/200 mm pijp L = 250 mm Zwart	97,20	A
Z1101230	ICS 25 RVS Ø 150/200 mm stormkraag Zwart	51,40	A
Z1101630	ICS 25 RVS Ø 150/200 mm Trekkap zonder gaas Zwart	116,40	A
Z1101730	ICS 25 RVS Ø 150/200 mm Trekkap met gaas Zwart	130,70	A
Z1102230	ICS 25 RVS Ø 150/200 mm dakplaat 0° Zwart	92,70	A
Z1102530	ICS 25 RVS Ø 150/200 mm loodslab 20°- 45° Zwart	252,40	A
Z1102630	ICS 25 RVS Ø 150/200 mm loodslab 45°- 60° Zwart	288,00	A
Z1100040	ICS 25 RVS Ø 180/230 mm pijp L = 1000 mm Zwart	192,80	A
Z1100140	ICS 25 RVS Ø 180/230 mm pijp L = 500 mm Zwart	117,90	A
Z1100240	ICS 25 RVS Ø 180/230 mm pijp L = 250 mm Zwart	108,20	A
Z1101240	ICS 25 RVS Ø 180/230 mm stormkraag Zwart	55,40	A
Z1101640	ICS 25 RVS Ø 180/230 mm Trekkap zonder gaas Zwart	137,20	A
Z1101740	ICS 25 RVS Ø 180/230 mm Trekkap met gaas Zwart	146,50	A
Z1102240	ICS 25 RVS Ø 180/230 mm dakplaat 0° Zwart	92,70	A
Z1102540	ICS 25 RVS Ø 180/230 mm loodslab 20°- 45° Zwart	314,30	A
Z1102640	ICS 25 RVS Ø 180/230 mm loodslab 45°- 60° Zwart	347,90	A
Z1100050	ICS 25 RVS Ø 200/250 mm pijp L = 1000 mm Zwart	218,30	A
Z1100150	ICS 25 RVS Ø 200/250 mm pijp L = 500 mm Zwart	144,80	A
Z1100250	ICS 25 RVS Ø 200/250 mm pijp L = 250 mm Zwart	124,20	A
Z1101250	ICS 25 RVS Ø 200/250 mm stormkraag Zwart	58,70	A
Z1101650	ICS 25 RVS Ø 200/250 mm Trekkap zonder gaas Zwart	149,30	A
Z1101750	ICS 25 RVS Ø 200/250 mm Trekkap met gaas Zwart	163,50	A
Z1102250	ICS 25 RVS Ø 200/250 mm dakplaat 0° Zwart	92,70	A
Z1102550	ICS 25 RVS Ø 200/250 mm loodslab 20°- 45° Zwart	314,30	A
Z1102650	ICS 25 RVS Ø 200/250 mm loodslab 45°- 60° Zwart	347,90	A



ROOKGASKANALEN

Dubbelwandig RVS UE met luchtspouw en lipring

Ø 80 / 95 mm
Luchtspouw



Artikelnr.	Omschrijving	Brutoprijs	Krt.G
1401000	UE Ø 80/95 mm pijp L = 1000 mm	57,20	A
1401010	UE Ø 80/95 mm pijp L = 500 mm	48,90	A
1401020	UE Ø 80/95 mm pijp L = 250 mm	43,90	A
1401030	UE Ø 80/95 mm pijp L = 150 mm	43,90	A
1401040	UE Ø 80/95 mm paspijp 220 - 335 mm	94,30	A
1401050	UE Ø 80/95 mm bocht 30°	77,50	A
1401060	UE Ø 80/95 mm bocht 45°	79,20	A
1401070	UE Ø 80/95 mm bocht 87°	79,20	A
1401080	UE Ø 80/95 mm T-stuk 87°	174,90	A
1401090	UE Ø 80/95 mm set centreerplaten	23,70	A
1401100	UE Ø 80/95 mm dakplaat hellend dak 5-30°	59,10	A
1401110	UE Ø 80/95 mm dakplaat platdak 0°	59,10	A
1401120	UE Ø 80/95 mm loodslab 20-45°	90,80	A
1401130	UE Ø 80/95 mm stormkraag	13,60	A
1401140	UE Ø 80/95 mm unikap	80,80	A
1401150	UE Ø 80/95 mm onderverloop	32,10	A
1401160	UE Ø 80/95 mm topsectie	52,30	A
1401170	UE Ø 80/95 mm condensdop	97,60	A
1401180	UE Ø 80/95 mm klemband	12,00	A
1401190	UE Ø 80/95 mm muurbeugel verstelbaar 25 - 50 mm	42,20	A
1401195	UE Ø 80/95 mm daksteunbeugel	50,00	A
1401200	UE Ø 80/95 mm verdiepingsteunplaat	37,10	A

Ø 100 / 115 mm
Luchtspouw



1401210	UE Ø 100/115 mm pijp L = 1000 mm	69,50	A
1401220	UE Ø 100/115 mm pijp L = 500 mm	53,90	A
1401230	UE Ø 100/115 mm pijp L = 250 mm	50,40	A
1401240	UE Ø 100/115 mm pijp L = 150 mm	46,90	A
1401250	UE Ø 100/115 mm paspijp 220 - 335 mm	97,20	A
1401260	UE Ø 100/115 mm bocht 30°	81,60	A
1401270	UE Ø 100/115 mm bocht 45°	81,60	A
1401280	UE Ø 100/115 mm bocht 87°	88,50	A
1401290	UE Ø 100/115 mm T-stuk 87°	183,70	A
1401300	UE Ø 100/115 mm T-stuk 87° Spruit 80mm	183,70	A
1401310	UE Ø 100/115 mm set centreerplaten	28,00	A
1401320	UE Ø 100/115 mm dakplaat hellend dak 5-30°	66,00	A
1401330	UE Ø 100/115 mm dakplaat platdak 0°	66,00	A
1401340	UE Ø 100/115 mm loodslab 20-45°	107,70	A
1401350	UE Ø 100/115 mm stormkraag	15,80	A
1401360	UE Ø 100/115 mm unikap	85,00	A
1401370	UE Ø 100/115 mm onderverloop	34,90	A
1401380	UE Ø 100/115 mm topsectie	60,80	A
1401390	UE Ø 100/115 mm condensdop	102,20	A
1401400	UE Ø 100/115 mm klemband	14,10	A
1401410	UE Ø 100/115 mm muurbeugel verstelbaar 25 - 50 mm	43,50	A
1401420	UE Ø 100/115 mm verdiepingsteunplaat	41,70	A

Standaard geleverd zonder klemband

ROOKGASKANALEN

Dubbelwandig RVS UE met luchtspouw en lipring

Ø 130 / 145 mm
Luchtspouw



Artikelnr.	Omschrijving	Brutoprijs	Krt.G
1401430	UE Ø 130/145 mm pijp L = 1000 mm	77,50	A
1401440	UE Ø 130/145 mm pijp L = 500 mm	60,60	A
1401450	UE Ø 130/145 mm pijp L = 250 mm	52,30	A
1401460	UE Ø 130/145 mm pijp L = 150 mm	48,90	A
1401470	UE Ø 130/145 mm paspijp 220-335 mm	94,30	A
1401480	UE Ø 130/145 mm bocht 30°	79,20	A
1401490	UE Ø 130/145 mm bocht 45°	79,20	A
1401500	UE Ø 130/145 mm bocht 87°	90,80	A
1401510	UE Ø 130/145 mm T-stuk 87°	181,60	A
1401520	UE Ø 130/145 mm T-stuk 87° spruit 80mm	181,60	A
1401530	UE Ø 130/145 mm set centreerplaten	30,30	A
1401540	UE Ø 130/145 mm tuidraadbeugel	48,90	A
1401550	UE Ø 130/145 mm dakplaat hellend dak 5-30°	74,10	A
1401560	UE Ø 130/145 mm dakplaat platdak 0°	74,10	A
1401570	UE Ø 130/145 mm loodslab 20-45°	111,10	A
1401580	UE Ø 130/145 mm stormkraag	16,90	A
1401590	UE Ø 130/145 mm unikap	95,90	A
1401600	UE Ø 130/145 mm onderverloop	38,90	A
1401610	UE Ø 130/145 mm topsectie	64,00	A
1401620	UE Ø 130/145 mm condensdop	104,40	A
1401630	UE Ø 130/145 mm klemband	15,20	A
1401640	UE Ø 130/145 mm muurbeugel verstelbaar 25 - 50 mm	42,20	A
1401650	UE Ø 130/145 mm verdiepingsteunplaat	42,20	A

Ø 150 / 165 mm
Luchtspouw



1401660	UE Ø 150/165 mm pijp L = 1000 mm	102,60	A
1401670	UE Ø 150/165 mm pijp L = 500 mm	74,10	A
1401680	UE Ø 150/165 mm pijp L = 250 mm	57,20	A
1401690	UE Ø 150/165 mm pijp L = 150 mm	48,90	A
1401700	UE Ø 150/165 mm paspijp 220 - 335 mm	99,20	A
1401710	UE Ø 150/165 mm bocht 30°	79,20	A
1401720	UE Ø 150/165 mm bocht 45°	79,20	A
1401730	UE Ø 150/165 mm bocht 87°	97,60	A
1401740	UE Ø 150/165 mm T-stuk 87°	190,10	A
1401750	UE Ø 150/165 mm T-stuk 87° spruit 80mm	190,10	A
1401760	UE Ø 150/165 mm set centreerplaten	33,70	A
1401770	UE Ø 150/165 mm tuidraadbeugel	50,50	A
1401780	UE Ø 150/165 mm dakplaat hellend dak 5-30°	77,50	A
1401790	UE Ø 150/165 mm dakplaat platdak 0°	77,50	A
1401800	UE Ø 150/165 mm loodslab 20-45°	127,90	A
1401810	UE Ø 150/165 mm stormkraag	16,90	A
1401820	UE Ø 150/165 mm unikap	126,10	A
1401830	UE Ø 150/165 mm onderverloop	40,40	A
1401840	UE Ø 150/165 mm topsectie	65,70	A
1401850	UE Ø 150/165 mm condensdop	111,10	A
1401860	UE Ø 150/165 mm klemband	15,20	A
1401870	UE Ø 150/165 mm muurbeugel verstelbaar 50 - 90 mm	45,50	A
1401880	UE Ø 150/165 mm verdiepingsteunplaat	48,90	A

Standaard geleverd zonder klemband



ROOKGASKANALEN

Dubbelwandig RVS UE met luchtspouw en lipring

Ø 180 / 195 mm
Luchtspouw



Artikelnr.	Omschrijving	Brutoprijs	Krt.G
1401890	UE Ø 180/195 mm pijp L = 1000 mm	109,40	A
1401900	UE Ø 180/195 mm pijp L = 500 mm	80,80	A
1401910	UE Ø 180/195 mm pijp L = 250 mm	59,00	A
1401920	UE Ø 180/195 mm pijp L = 150 mm	52,30	A
1401930	UE Ø 180/195 mm paspijp 220 - 335 mm	107,70	A
1401940	UE Ø 180/195 mm bocht 30°	79,20	A
1401950	UE Ø 180/195 mm bocht 45°	79,20	A
1401960	UE Ø 180/195 mm bocht 87°	97,60	A
1401970	UE Ø 180/195 mm T-stuk 87°	198,40	A
1401980	UE Ø 180/195 mm T-stuk 87° Spruit 80mm	198,40	A
1401990	UE Ø 180/195 mm set centreerplaten	37,10	A
1402000	UE Ø 180/195 mm tuidraadbeugel	52,20	A
1402010	UE Ø 180/195 mm dakplaat hellend dak 5-30°	80,80	A
1402020	UE Ø 180/195 mm dakplaat platdak 0°	80,80	A
1402030	UE Ø 180/195 mm loodslab 20-45°	144,70	A
1402040	UE Ø 180/195 mm stormkraag	18,60	A
1402050	UE Ø 180/195 mm unikap	144,70	A
1402060	UE Ø 180/195 mm onderverloop	42,30	A
1402070	UE Ø 180/195 mm topsectie	75,80	A
1402080	UE Ø 180/195 mm condensdop	107,80	A
1402090	UE Ø 180/195 mm klemband	15,20	A
1402100	UE Ø 180/195 mm muurbeugel verstelbaar 50 - 90 mm	45,50	A
1402110	UE Ø 180/195 mm verdiepingsteunplaat	57,20	A

Ø 200 / 215 mm
Luchtspouw



1402120	UE Ø 200/215 mm pijp L = 1000 mm	117,80	A
1402130	UE Ø 200/215 mm pijp L = 500 mm	85,80	A
1402140	UE Ø 200/215 mm pijp L = 250 mm	60,60	A
1402150	UE Ø 200/215 mm pijp L = 150 mm	57,20	A
1402160	UE Ø 200/215 mm paspijp 220 - 335 mm	112,70	A
1402170	UE Ø 200/215 mm bocht 30°	90,90	A
1402180	UE Ø 200/215 mm bocht 45°	90,90	A
1402190	UE Ø 200/215 mm bocht 87°	112,70	A
1402200	UE Ø 200/215 mm T-stuk 87°	210,30	A
1402210	UE Ø 200/215 mm T-stuk 87° Spruit 80mm	210,30	A
1402220	UE Ø 200/215 mm set centreerplaten	40,40	A
1402230	UE Ø 200/215 mm tuidraadbeugel	52,30	A
1402240	UE Ø 200/215 mm dakplaat hellend dak 5-30°	85,80	A
1402250	UE Ø 200/215 mm dakplaat platdak 0°	85,80	A
1402260	UE Ø 200/215 mm loodslab 20-45°	165,00	A
1402270	UE Ø 200/215 mm stormkraag	18,70	A
1402280	UE Ø 200/215 mm unikap	165,00	A
1402290	UE Ø 200/215 mm onderverloop	45,50	A
1402300	UE Ø 200/215 mm topsectie	80,80	A
1402310	UE Ø 200/215 mm condensdop	124,60	A
1402320	UE Ø 200/215 mm klemband	16,90	A
1402330	UE Ø 200/215 mm muurbeugel verstelbaar 50 - 90 mm	50,50	A
1402340	UE Ø 200/215 mm verdiepingsteunplaat	60,60	A

Standaard geleverd zonder klemband

ROOKGASKANALEN

Dubbelwandig RVS UE met luchtspouw en lipring

Ø 250 / 265 mm
Luchtspouw



Artikelnr.	Omschrijving	Brutoprijs	Krt.G
1402350	UE Ø 250/265 mm pijp L = 1000 mm	134,70	A
1402360	UE Ø 250/265 mm pijp L = 500 mm	101,00	A
1402370	UE Ø 250/265 mm pijp L = 250 mm	67,40	A
1402380	UE Ø 250/265 mm pijp L = 150 mm	64,00	A
1402390	UE Ø 250/265 mm paspijp 220 - 335 mm	127,90	A
1402400	UE Ø 250/265 mm bocht 30°	109,40	A
1402410	UE Ø 250/265 mm bocht 45°	107,80	A
1402420	UE Ø 250/265 mm bocht 87°	127,90	A
1402430	UE Ø 250/265 mm T-stuk 87°	232,00	A
1402440	UE Ø 250/265 mm T-stuk 87° Spruit 80mm	232,00	A
1402450	UE Ø 250/265 mm set centreerplaten	47,20	A
1402460	UE Ø 250/265 mm tuidraadbeugel	54,00	A
1402470	UE Ø 250/265 mm dakplaat hellend dak 5-30°	97,60	A
1402480	UE Ø 250/265 mm dakplaat platdak	97,60	A
1402490	UE Ø 250/265 mm loodslab 20-45°	218,60	A
1402500	UE Ø 250/265 mm stormkraag	22,00	A
1402510	UE Ø 250/265 mm unikap	198,40	A
1402520	UE Ø 250/265 mm onderverloop	48,90	A
1402530	UE Ø 250/265 mm topsectie	97,60	A
1402540	UE Ø 250/265 mm condensdop	134,70	A
1402550	UE Ø 250/265 mm klemband	16,90	A
1402560	UE Ø 250/265 mm muurbeugel verstelbaar 50 - 90 mm	52,30	A
1402570	UE Ø 250/265 mm verdiepingsteunplaat	65,70	A

Standaard geleverd zonder klemband



HOOFDSTUK 3

Rookgaskanalen Enkelwandig

Omschrijving	Pagina
Enkelwandig RVS blank Kachel/open haardkanaal Ø 125 mm - Ø 150 mm - Ø 180 mm	32
Enkelwandig RVS blank Kachel/open haardkanaal Ø 200 mm - verlopen	33
Enkelwandig RVS zwart Kachel/open haardkanaal Ø 125 mm - Ø 150 mm - Ø 180 mm	35
Enkelwandig RVS zwart Kachel/open haardkanaal Ø 200 mm	36
E.W. blauw gegloeid Ø 98 mm - Ø 100 mm - Ø 111 mm - Ø 125 mm - Ø 131 mm - Ø 150 mm	37
Enkelwandig blauw gegloeid Ø 180 mm - Ø 200 mm - verlopen - rozetten	38
Enkelwandig zwart dikwandig 2 mm Ø 120 mm - Ø 130 mm - Ø 150 mm	39
Enkelwandig antraciet dikwandig 2 mm Ø 150 mm	40
Enkelwandig zwart dikwandig 2 mm Ø 160 mm - Ø 180 mm	40
Enkelwandig zwart dikwandig 2 mm Ø 200 mm - Ø 250 mm - verlopen	41
Enkelwandig RVS blank Pelletkachelkanaal Ø 80 mm - Ø 100 mm	42
Enkelwandig Living Pellet zwart en RVS zwart Pelletkachelkanaal Ø 80 mm - Ø 100 mm	43
Systeem overzicht Living Pellet Schiedel	44
Enkelwandig RVS blank Prima Plus Ø 130 mm - Ø 150 mm	45
Enkelwandig RVS blank Prima Plus Ø 180 mm - Ø 200 mm	46
Enkelwandig RVS blank Prima Plus Ø 250 mm - Ø 300 mm	47
Enkelwandig RVS blank Prima Plus Ø 350 mm - verlopen	48
Enkelwandig RVS blank ME met lipring Ø 80 mm - Ø 100 mm	49
Enkelwandig RVS blank ME met lipring Ø 113 mm - Ø 130 mm	50
Enkelwandig RVS blank ME met lipring Ø 150 mm - Ø 180 mm	51
Enkelwandig RVS blank ME met lipring Ø 200 mm - Ø 250 mm	53
Enkelwandig RVS blank ME met lipring Ø 300 mm - Ø 350 mm	54
Enkelwandig RVS blank ME met lipring Ø 400 mm - Ø 450 mm	55



ROOKGASKANALEN

Enkelwandig RVS blank Kachel/Open Haardkanaal Rite Vent - Schiedel

Blank RVS
 Ø 125 mm



Artikelnr.	Omschrijving	Brutoprijs	Krt.G
1200010	Blank RVS Ø 125 mm pijp L = 1000 mm	41,20	A
1200020	Blank RVS Ø 125 mm pijp L = 500 mm	23,80	A
1200030	Blank RVS Ø 125 mm pijp L = 250 mm	18,80	A
1200070	Blank RVS Ø 125 mm paspijp L = 200 mm	33,40	A
1200040	Blank RVS Ø 125 mm inspectiepijp L = 1000 mm *	77,00	A
1200050	Blank RVS Ø 125 mm inspectiepijp L = 500 mm *	51,10	A
1200060	Blank RVS Ø 125 mm inspectiepijp L = 300 mm *	41,80	A
1200120	Blank RVS Ø 125 mm bocht 90°	42,70	A
1200100	Blank RVS Ø 125 mm bocht 45°	33,00	A
1200110	Blank RVS Ø 125 mm bocht 30°	31,40	A
1200130	Blank RVS Ø 125 mm inspectiebocht 90° *	59,00	A
1200140	Blank RVS Ø 125 mm inspectiebocht 45° *	57,30	A
1200150	Blank RVS Ø 125 mm T-Stuk 90°	51,40	A
1200080	Blank RVS Ø 125 mm dop voor T-stuk	23,30	A
1200155	Blank RVS Ø 125 mm rozet	11,80	A

Blank RVS
 Ø 150 mm



1200180	Blank RVS Ø 150 mm pijp L = 1000 mm	47,80	A
1200190	Blank RVS Ø 150 mm pijp L = 500 mm	27,00	A
1200200	Blank RVS Ø 150 mm pijp L = 250 mm	20,90	A
1200240	Blank RVS Ø 150 mm paspijp L = 200 mm	35,80	A
1200210	Blank RVS Ø 150 mm inspectiepijp L = 1000 mm *	89,20	A
1200220	Blank RVS Ø 150 mm inspectiepijp L = 500 mm *	56,40	A
1200230	Blank RVS Ø 150 mm inspectiepijp L = 300 mm *	45,60	A
1200290	Blank RVS Ø 150 mm bocht 90°	44,40	A
1200270	Blank RVS Ø 150 mm bocht 45°	35,60	A
1200280	Blank RVS Ø 150 mm bocht 30°	34,30	A
1200300	Blank RVS Ø 150 mm inspectiebocht 90° *	63,50	A
1200310	Blank RVS Ø 150 mm inspectiebocht 45° *	60,80	A
1200320	Blank RVS Ø 150 mm T-Stuk 90°	57,70	A
1200250	Blank RVS Ø 150 mm dop voor T-stuk	19,30	A
1200325	Blank RVS Ø 150 mm rozet	12,10	A

Blank RVS
 Ø 180 mm



1200350	Blank RVS Ø 180 mm pijp L = 1000 mm	55,70	A
1200360	Blank RVS Ø 180 mm pijp L = 500 mm	31,30	A
1200370	Blank RVS Ø 180 mm pijp L = 250 mm	24,40	A
1200410	Blank RVS Ø 180 mm paspijp L = 200 mm	40,00	A
1200380	Blank RVS Ø 180 mm inspectiepijp L = 1000 mm *	96,70	A
1200390	Blank RVS Ø 180 mm inspectiepijp L = 500 mm *	64,00	A
1200400	Blank RVS Ø 180 mm inspectiepijp L = 300 mm *	49,20	A
1200460	Blank RVS Ø 180 mm bocht 90°	48,50	A
1200440	Blank RVS Ø 180 mm bocht 45°	39,10	A
1200450	Blank RVS Ø 180 mm bocht 30°	36,60	A
1200470	Blank RVS Ø 180 mm inspectiebocht 90° *	67,90	A
1200480	Blank RVS Ø 180 mm inspectiebocht 45° *	64,40	A
1200490	Blank RVS Ø 180 mm T-Stuk 90°	79,50	A
1200420	Blank RVS Ø 180 mm dop voor T-stuk	20,30	A

* Niet uit voorraad leverbaar

SCHIEDEL



ROOKGASKANALEN

Enkelwandig RVS blank Kachel/Open Haardkanaal Rite Vent - Schiedel

Blank RVS
 Ø 200 mm



Artikelnr.	Omschrijving	Brutoprijs	Krt.G
1200520	Blank RVS Ø 200 mm pijp L = 1000 mm	60,70	A
1200530	Blank RVS Ø 200 mm pijp L = 500 mm	33,80	A
1200540	Blank RVS Ø 200 mm pijp L = 250 mm	26,20	A
1200580	Blank RVS Ø 200 mm paspijp L = 200 mm	42,00	A
1200550	Blank RVS Ø 200 mm inspectiepijp L = 1000 mm *	103,60	A
1200560	Blank RVS Ø 200 mm inspectiepijp L = 500 mm *	67,50	A
1200570	Blank RVS Ø 200 mm inspectiepijp L = 300 mm *	51,20	A
1200630	Blank RVS Ø 200 mm bocht 90°	50,90	A
1200610	Blank RVS Ø 200 mm bocht 45°	40,80	A
1200620	Blank RVS Ø 200 mm bocht 30°	37,90	A
1200640	Blank RVS Ø 200 mm inspectiebocht 90° *	70,60	A
1200650	Blank RVS Ø 200 mm inspectiebocht 45° *	66,90	A
1200660	Blank RVS Ø 200 mm T-Stuk 90°	83,50	A
1200590	Blank RVS Ø 200 mm dop voor T-stuk	20,70	A

* Niet uit voorraad leverbaar

Blank RVS
 Verlopen



1200770	Blank RVS verloop Ø 80 - 100 mm	39,20	A
1200775	Blank RVS verloop Ø 80 - 110 mm	69,10	A
1200774	Blank RVS verloop Ø 80 - 125 mm	69,10	A
1200705	Blank RVS verloop Ø 80 - 130 mm	69,10	A
1200706	Blank RVS verloop Ø 80 - 150 mm	69,10	A
1200765	Blank RVS verloop Ø 90 - 100 mm	39,20	A
1200756	Blank RVS verloop Ø 90 - 110 mm	39,20	A
1200755	Blank RVS verloop Ø 100 - 110 mm	39,20	A
1200777	Blank RVS verloop Ø 100 - 125 mm	60,80	A
1200745	Blank RVS verloop Ø 100 - 130 mm	69,10	A
1200760	Blank RVS verloop Ø 100 - 150 mm	69,10	A
1200748	Blank RVS verloop Ø 110 - 130 mm	69,10	A
1200752	Blank RVS verloop Ø 120 - 130 mm	69,10	A
1200170	Blank RVS verloop Ø 125 - 150 mm (Prima Smooth)	38,60	A
1200700	Blank RVS verloop Ø 130 - 150 mm	69,10	A
1200718	Blank RVS verloop Ø 130 - 180 mm	75,50	A
1200717	Blank RVS verloop Ø 130 - 200 mm	78,80	A
1200702	Blank RVS verloop Ø 140 - 150 mm	69,10	A
1200715	Blank RVS verloop Ø 150 - 160 mm	69,10	A
1200710	Blank RVS verloop Ø 150 - 180 mm	69,10	A
1200720	Blank RVS verloop Ø 150 - 200 mm	78,80	A
1200780	Blank RVS verloop Ø 175 - 200 mm	78,80	A
1200730	Blank RVS verloop Ø 180 - 200 mm	78,80	A
1200750	Blank RVS verloop Ø 180 - 250 mm	101,50	A
1200740	Blank RVS verloop Ø 200 - 250 mm	101,50	A
1200746	Blank RVS verloop Ø 250 - 300 mm	101,50	A
1200754	Blank RVS verloop Ø 300 - 400 mm	107,70	A

SCHIEDEL



PRIMA SMOOTH

*Het Enkelwandig Roestvrij Staal
Aansluitkanaal en Schoorsteenkanaal
(voor Hout & Multi-brandstof toepassingen)*



ROOKGASKANALEN

Enkelwandig RVS zwart Kachel/Open Haardkanaal Rite Vent - Schiedel

Zwart RVS
 Ø 125 mm



Artikelnr.	Omschrijving	Brutoprijs	Krt.G
1210010	Zwart RVS Ø 125 mm pijp L= 1000 mm	69,80	A
1210020	Zwart RVS Ø 125 mm pijp L = 500 mm	38,20	A
1210030	Zwart RVS Ø 125 mm pijp L = 250 mm	27,00	A
1210070	Zwart RVS Ø 125 mm paspijp L = 200 mm	44,20	A
1210040	Zwart RVS Ø 125 mm inspectiepijp L = 1000 mm *	95,80	A
1210050	Zwart RVS Ø 125 mm inspectiepijp L = 500 mm *	60,20	A
1210060	Zwart RVS Ø 125 mm inspectiepijp L = 300 mm *	48,30	A
1210120	Zwart RVS Ø 125 mm bocht 90°	47,80	A
1210100	Zwart RVS Ø 125 mm bocht 45°	38,30	A
1210110	Zwart RVS Ø 125 mm bocht 30°	35,60	A
1210130	Zwart RVS Ø 125 mm inspectiebocht 90° *	64,40	A
1210140	Zwart RVS Ø 125 mm inspectiebocht 45° *	62,50	A
1210150	Zwart RVS Ø 125 mm T-Stuk 90°	58,60	A
1210080	Zwart RVS Ø 125 mm dop voor T-stuk	21,90	A
1210175	Zwart RVS Ø 125 mm rozet	14,00	A
1210170	Zwart RVS verloop Ø 125 - 150 mm	40,30	A

Zwart RVS
 Ø 150 mm



1210180	Zwart RVS Ø 150 mm pijp L= 1000 mm	73,90	A
1210190	Zwart RVS Ø 150 mm pijp L = 500 mm	42,60	A
1210200	Zwart RVS Ø 150 mm pijp L = 250 mm	29,40	A
1210240	Zwart RVS Ø 150 mm paspijp L = 200 mm	44,20	A
1210210	Zwart RVS Ø 150 mm inspectiepijp L = 1000 mm *	111,80	A
1210220	Zwart RVS Ø 150 mm inspectiepijp L = 500 mm *	67,40	A
1210230	Zwart RVS Ø 150 mm inspectiepijp L = 300 mm *	54,80	A
1210290	Zwart RVS Ø 150 mm bocht 90°	54,50	A
1210270	Zwart RVS Ø 150 mm bocht 45°	43,80	A
1210280	Zwart RVS Ø 150 mm bocht 30°	37,00	A
1210300	Zwart RVS Ø 150 mm inspectiebocht 90° *	71,80	A
1210310	Zwart RVS Ø 150 mm inspectiebocht 45° *	69,20	A
1210320	Zwart RVS Ø 150 mm T-Stuk 90°	67,50	A
1210250	Zwart RVS Ø 150 mm dop voor T-stuk	22,40	A
1210345	Zwart RVS Ø 150 mm rozet	17,00	A
1210340	Zwart RVS verloop Ø 150 - 180 mm	55,30	A

Zwart RVS
 Ø 180 mm



1210350	Zwart RVS Ø 180 mm pijp L= 1000 mm	77,70	A
1210360	Zwart RVS Ø 180 mm pijp L = 500 mm	43,10	A
1210370	Zwart RVS Ø 180 mm pijp L = 250 mm	31,30	A
1210410	Zwart RVS Ø 180 mm paspijp L = 200 mm	46,90	A
1210380	Zwart RVS Ø 180 mm inspectiepijp L = 1000 mm *	124,30	A
1210390	Zwart RVS Ø 180 mm inspectiepijp L = 500 mm *	77,40	A
1210400	Zwart RVS Ø 180 mm inspectiepijp L = 300 mm *	57,50	A
1210460	Zwart RVS Ø 180 mm bocht 90°	56,60	A
1210440	Zwart RVS Ø 180 mm bocht 45°	43,80	A
1210450	Zwart RVS Ø 180 mm bocht 30°	38,50	A
1210470	Zwart RVS Ø 180 mm inspectiebocht 90° *	76,40	A
1210480	Zwart RVS Ø 180 mm inspectiebocht 45° *	73,10	A
1210490	Zwart RVS Ø 180 mm T-Stuk 90°	98,60	A
1210420	Zwart RVS Ø 180 mm dop voor T-stuk	25,20	A

* Niet uit voorraad leverbaar



ROOKGASKANALEN

Enkelwandig RVS zwart Kachel/Open Haardkanaal Rite Vent - Schiedel

Zwart RVS
Ø 200 mm



Artikelnr.	Omschrijving	Brutoprijs	Krt.G
1210520	Zwart RVS Ø 200 mm pijp L= 1000 mm	84,80	A
1210530	Zwart RVS Ø 200 mm pijp L = 500 mm	45,80	A
1210540	Zwart RVS Ø 200 mm pijp L = 250 mm	33,80	A
1210580	Zwart RVS Ø 200 mm paspijp L = 200 mm	48,70	A
1210550	Zwart RVS Ø 200 mm inspectiepijp L = 1000 mm *	134,20	A
1210560	Zwart RVS Ø 200 mm inspectiepijp L = 500 mm *	84,80	A
1210570	Zwart RVS Ø 200 mm inspectiepijp L = 300 mm *	60,20	A
1210630	Zwart RVS Ø 200 mm bocht 90°	60,70	A
1210610	Zwart RVS Ø 200 mm bocht 45°	48,10	A
1210620	Zwart RVS Ø 200 mm bocht 30°	41,90	A
1210640	Zwart RVS Ø 200 mm inspectiebocht 90° *	80,20	A
1210650	Zwart RVS Ø 200 mm inspectiebocht 45° *	76,60	A
1210660	Zwart RVS Ø 200 mm T-Stuk 90°	104,70	A
1210590	Zwart RVS Ø 200 mm dop voor T-stuk	28,20	A

* Niet uit voorraad leverbaar



ROOKGASKANALEN

Enkelwandig Blauw Gegloeid Kachel/Open Haardkanaal

	Artikelnr.	Omschrijving	Brutoprijs	Krt.G
Blauw Gegloeid Ø 98 mm	1500515	Blauw gegloeid Ø 98 mm pijp L= 1000 mm	13,80	A
	1500516	Blauw gegloeid Ø 98 mm bocht 90°	10,30	A
	1500517	Blauw gegloeid Ø 98 mm bocht 45°	9,00	A
	1500518	Blauw gegloeid Ø 98 mm rozet	6,90	A
Blauw Gegloeid Ø 100 mm	1500400	Blauw gegloeid Ø 100 mm pijp L = 1000 mm	15,20	A
	1500405	Blauw gegloeid Ø 100 mm bocht 90°	17,60	A
	1500406	Blauw gegloeid Ø 100 mm bocht 45°	16,30	A
	1500410	Blauw gegloeid Ø 100 mm T-stuk + Dop	51,20	A
	1500518	Blauw gegloeid Ø 100 mm rozet	6,90	A
	1500490	Blauw gegloeid Ø 100 - 111 mm klepsleutel	13,80	A
Blauw Gegloeid Ø 111 mm	1500510	Blauw gegloeid Ø 111 mm pijp L= 1000 mm	15,20	A
	1500570	Blauw gegloeid Ø 111 mm bocht 90°	10,30	A
	1500630	Blauw gegloeid Ø 111 mm bocht 45°	9,00	A
	1500725	Blauw gegloeid Ø 111 mm T-stuk + dop	32,40	A
	1500730	Blauw gegloeid Ø 111 mm rozet	6,30	A
	1500910	Blauw gegloeid Ø 111 mm roetzakpijp	45,00	A
	1500920	Blauw gegloeid Ø 111 mm haardaansluiting recht	27,60	A
	1500490	Blauw gegloeid Ø 100 - 111 mm klepsleutel	13,80	A
Blauw Gegloeid Ø 125 mm	1500520	Blauw gegloeid Ø 125 mm pijp L = 1000 mm	16,70	A
	1500580	Blauw gegloeid Ø 125 mm bocht 90°	11,00	A
	1500640	Blauw gegloeid Ø 125 mm bocht 45°	9,60	A
	1500690	Blauw gegloeid Ø 125 mm T-stuk + dop	47,30	A
	1500745	Blauw gegloeid Ø 125 mm rozet	9,60	A
	1500491	Blauw gegloeid Ø 125 - 131 mm klepsleutel	15,80	A
Blauw Gegloeid Ø 131 mm	1500530	Blauw gegloeid Ø 131 mm pijp L = 1000mm	18,20	A
	1500590	Blauw gegloeid Ø 131 mm bocht 90°	11,30	A
	1500650	Blauw gegloeid Ø 131 mm bocht 45°	9,90	A
	1500735	Blauw gegloeid Ø 131 mm T-stuk + dop	38,30	A
	1500750	Blauw gegloeid Ø 131 mm rozet	6,90	A
	1500491	Blauw gegloeid Ø 125 - 131 mm klepsleutel	15,80	A
Blauw Gegloeid Ø 150 mm	1500540	Blauw gegloeid Ø 150 mm pijp L = 1000mm	19,80	A
	1500600	Blauw gegloeid Ø 150 mm bocht 90°	12,40	A
	1500660	Blauw gegloeid Ø 150 mm bocht 45°	9,60	A
	1500700	Blauw gegloeid Ø 150 mm T-stuk + dop	53,90	A
	1500765	Blauw gegloeid Ø 150 mm rozet	7,60	A
	1500492	Blauw gegloeid Ø 150 mm klepsleutel	17,10	A

ROOKGASKANALEN

Enkelwandig Blauw Gegloeid Kachel/Open Haardkanaal

Blauw Gegloeid Ø 180 mm



ArtikeInr.	Omschrijving	Brutoprijs	Krt.G
1500550	Blauw gegloeid Ø 180 mm pijp L = 1000 mm	24,00	A
1500610	Blauw gegloeid Ø 180 mm bocht 90°	17,20	A
1500670	Blauw gegloeid Ø 180 mm bocht 45°	13,10	A
1500715	Blauw gegloeid Ø 180 mm T-stuk + dop	48,20	A
1500770	Blauw gegloeid Ø 180 mm rozet	14,20	A
1500493	Blauw gegloeid Ø 180 mm klepsleutel	19,30	A

Blauw Gegloeid Ø 200 mm



1500560	Blauw gegloeid Ø 200 mm pijp L = 1000 mm	25,50	A
1500620	Blauw gegloeid Ø 200 mm bocht 90°	17,90	A
1500680	Blauw gegloeid Ø 200 mm bocht 45°	15,20	A
1500716	Blauw gegloeid Ø 200 mm T-stuk + dop	49,90	A
1500785	Blauw gegloeid Ø 200 mm rozet	16,80	A
1500494	Blauw gegloeid Ø 200 mm klepsleutel	21,30	A

Blauw Gegloeid Verlopen



1500825	Blauw gegloeid verloop Ø 90 - 100 mm	35,80	A
1500805	Blauw gegloeid verloop Ø 92 - 111 mm	23,20	A
1500800	Blauw gegloeid verloop Ø 98 - 111 mm	23,40	A
1500815	Blauw gegloeid verloop Ø 100 - 125 mm	35,80	A
1500816	Blauw gegloeid verloop Ø 100 - 131 mm	35,80	A
1500817	Blauw gegloeid verloop Ø 100 - 150 mm	35,80	A
1500810	Blauw gegloeid verloop Ø 105 - 111 mm	23,40	A
1500820	Blauw gegloeid verloop Ø 111 - 125 mm	23,40	A
1500830	Blauw gegloeid verloop Ø 111 - 131 mm	23,40	A
1500840	Blauw gegloeid verloop Ø 111 - 150 mm	27,70	A
1500855	Blauw gegloeid verloop Ø 120 - 150 mm	35,80	A
1500850	Blauw gegloeid verloop Ø 125 - 131 mm	23,40	A
1500860	Blauw gegloeid verloop Ø 125 - 150 mm	26,10	A
1500870	Blauw gegloeid verloop Ø 131 - 150 mm	24,40	A
1500880	Blauw gegloeid verloop Ø 150 - 180 mm	26,00	A
1500890	Blauw gegloeid verloop Ø 150 - 200 mm	26,10	A
1500900	Blauw gegloeid verloop Ø 180 - 200 mm	24,70	A

Verstelbare Rozetten

1500746	Verstelbaar rozet Ø 120 - 135 mm breedte 45 mm	15,70	A
1500766	Verstelbaar rozet Ø 140 - 165 mm breedte 45 mm	17,60	A
1500776	Verstelbaar rozet Ø 180 - 200 mm breedte 45 mm	20,60	A



ROOKGASKANALEN

Enkelwandig Dikwandig 2 mm staal Kachel/Open Haardkanaal

Zwart 2 mm
Ø 120 mm



Artikelnr.	Omschrijving	Brutoprijs	Krt.G
1501000	Zwart 2 mm Ø 120 mm pijp L = 1000 mm	50,30	A
1501010	Zwart 2 mm Ø 120 mm pijp L = 750 mm	49,60	A
1501020	Zwart 2 mm Ø 120 mm pijp L = 500 mm	36,00	A
1501030	Zwart 2 mm Ø 120 mm pijp L = 500 mm + klep	59,00	A
1501040	Zwart 2 mm Ø 120 mm pijp L = 250 mm	26,90	A
1501050	Zwart 2 mm Ø 120 mm pasijp L = 500 - 900 mm	68,00	A
1501060	Zwart 2 mm Ø 120 mm bocht 30°	45,10	A
1501070	Zwart 2 mm Ø 120 mm bocht 45°	45,10	A
1501080	Zwart 2 mm Ø 120 mm bocht 90°	45,10	A
1501090	Zwart 2 mm Ø 120 mm bocht 45°+ luik	54,60	A
1501100	Zwart 2 mm Ø 120 mm bocht 90°+ luik	54,60	A
1501110	Zwart 2 mm Ø 120 mm bocht verstelbaar + luik	62,30	A
1501120	Zwart 2 mm Ø 120 mm rozet	16,60	A
1501130	Zwart 2 mm Ø 120 mm muurbeugel	27,30	A
1501140	Zwart 2 mm Ø 120 mm T-stuk + dop	180,80	A

Zwart 2 mm
Ø 130 mm



1501200	Zwart 2 mm Ø 130 mm pijp L = 1000 mm	50,30	A
1501210	Zwart 2 mm Ø 130 mm pijp L = 750 mm	49,60	A
1501220	Zwart 2 mm Ø 130 mm pijp L = 500 mm	36,00	A
1501230	Zwart 2 mm Ø 130 mm pijp L = 500 mm + klep	59,00	A
1501240	Zwart 2 mm Ø 130 mm pijp L = 250 mm	26,90	A
1501250	Zwart 2 mm Ø 130 mm pasijp L = 500 - 900 mm	68,00	A
1501260	Zwart 2 mm Ø 130 mm bocht 30°	45,10	A
1501270	Zwart 2 mm Ø 130 mm bocht 45°	45,10	A
1501280	Zwart 2 mm Ø 130 mm bocht 90°	45,10	A
1501290	Zwart 2 mm Ø 130 mm bocht 45°+ luik	54,60	A
1501300	Zwart 2 mm Ø 130 mm bocht 90°+ luik	54,60	A
1501310	Zwart 2 mm Ø 130 mm bocht verstelbaar + luik	62,30	A
1501320	Zwart 2 mm Ø 130 mm rozet	16,60	A
1501330	Zwart 2 mm Ø 130 mm muurbeugel	27,30	A
1501340	Zwart 2 mm Ø 130 mm T-stuk + dop	180,80	A

Zwart 2 mm
Ø 150 mm



1501400	Zwart 2 mm Ø 150 mm pijp L = 1000 mm	50,30	A
1501410	Zwart 2 mm Ø 150 mm pijp L = 1000 mm + klep	73,50	A
1501420	Zwart 2 mm Ø 150 mm pijp L = 1000 mm + luik	61,50	A
1501430	Zwart 2 mm Ø 150 mm pijp L = 750 mm	49,60	A
1501440	Zwart 2 mm Ø 150 mm pijp L = 500 mm	36,00	A
1501450	Zwart 2 mm Ø 150 mm pijp L = 500 mm + klep	59,00	A
1501460	Zwart 2 mm Ø 150 mm pijp L = 250 mm	26,90	A
1501470	Zwart 2 mm Ø 150 mm pasijp L = 500 - 900 mm	70,30	A
1501475	Zwart 2 mm Ø 150 mm pasijp L = 330 mm	61,80	A
1501490	Zwart 2 mm Ø 150 mm bocht 15°	45,10	A
1501500	Zwart 2 mm Ø 150 mm bocht 30°	45,10	A
1501510	Zwart 2 mm Ø 150 mm bocht 45°	45,10	A
1501520	Zwart 2 mm Ø 150 mm bocht 90°	45,10	A
1501530	Zwart 2 mm Ø 150 mm bocht 45°+ luik	54,60	A
1501540	Zwart 2 mm Ø 150 mm bocht 90°+ luik	54,60	A
1501550	Zwart 2 mm Ø 150 mm bocht verstelbaar + luik	62,30	A
1501560	Zwart 2 mm Ø 150 mm rozet	16,60	A
1501570	Zwart 2 mm Ø 150 mm muurbeugel	27,30	A
1501580	Zwart 2 mm Ø 150 mm T-stuk + dop	146,10	A
1501590	Zwart 2 mm Ø 150 mm kachelaansluiting	24,70	A
1501595	Nisbus blank 2 mm Ø 150 mm	23,50	A

ROOKGASKANALEN

Enkelwandig Dikwandig 2 mm staal Kachel/Open Haardkanaal

Antraciet 2 mm
Ø 150 mm



Artikelnr.	Omschrijving	Brutoprijs	Krt.G
1501600	Antraciet 2 mm Ø 150 mm pijp L = 1000 mm	50,30	A
1501610	Antraciet 2 mm Ø 150 mm pijp L = 1000 mm + klep	73,50	A
1501620	Antraciet 2 mm Ø 150 mm pijp L = 1000 mm + luik	61,40	A
1501630	Antraciet 2 mm Ø 150 mm pijp L = 750 mm	49,60	A
1501640	Antraciet 2 mm Ø 150 mm pijp L = 500 mm	36,00	A
1501650	Antraciet 2 mm Ø 150 mm pijp L = 500 mm + klep	59,00	A
1501660	Antraciet 2 mm Ø 150 mm pijp L = 250 mm	26,90	A
1501670	Antraciet 2 mm Ø 150 mm pasijp L = 400 mm	36,70	A
1501680	Antraciet 2 mm Ø 150 mm pasijp L = 1000 mm	51,50	A
1501690	Antraciet 2 mm Ø 150 mm bocht 15°	45,10	A
1501700	Antraciet 2 mm Ø 150 mm bocht 30°	45,10	A
1501710	Antraciet 2 mm Ø 150 mm bocht 45°	45,10	A
1501720	Antraciet 2 mm Ø 150 mm bocht 90°	45,10	A
1501730	Antraciet 2 mm Ø 150 mm bocht 45°+ luik	54,60	A
1501740	Antraciet 2 mm Ø 150 mm bocht 90°+ luik	54,60	A
1501750	Antraciet 2 mm Ø 150 mm bocht verstelbaar + luik	62,30	A
1501760	Antraciet 2 mm Ø 150 mm rozet	16,60	A
1501770	Antraciet 2 mm Ø 150 mm muurbeugel	27,30	A
1501780	Antraciet 2 mm Ø 150 mm T-stuk + dop	146,10	A
1501790	Antraciet 2 mm Ø 150 mm kachelaansluiting	24,70	A
1501595	Nisbus blank 2 mm Ø 150 mm	23,50	A

Zwart 2 mm
Ø 160 mm



1501800	Zwart 2 mm Ø 160 mm pijp L = 1000 mm	52,80	A
1501810	Zwart 2 mm Ø 160 mm pijp L = 750 mm	61,70	A
1501820	Zwart 2 mm Ø 160 mm pijp L = 500 mm	37,70	A
1501830	Zwart 2 mm Ø 160 mm pijp L = 500 mm + klep	60,80	A
1501840	Zwart 2 mm Ø 160 mm pijp L = 250 mm	28,20	A
1501850	Zwart 2 mm Ø 160 mm pasijp L = 400 mm	38,20	A
1501860	Zwart 2 mm Ø 160 mm bocht 45°	47,00	A
1501870	Zwart 2 mm Ø 160 mm bocht 90°	47,00	A
1501880	Zwart 2 mm Ø 160 mm bocht verstelbaar + luik	64,20	A
1501890	Zwart 2 mm Ø 160 mm rozet	17,50	A
1501900	Zwart 2 mm Ø 160 mm muurbeugel	29,30	A

Zwart 2 mm
Ø 180 mm



1502000	Zwart 2 mm Ø 180 mm pijp L = 1000 mm	56,50	A
1502010	Zwart 2 mm Ø 180 mm pijp L = 750 mm	55,30	A
1502020	Zwart 2 mm Ø 180 mm pijp L = 500 mm	40,60	A
1502030	Zwart 2 mm Ø 180 mm pijp L = 500 mm + klep	63,70	A
1502040	Zwart 2 mm Ø 180 mm pijp L = 250 mm	29,90	A
1502050	Zwart 2 mm Ø 180 mm pasijp L = 400 mm	41,40	A
1502060	Zwart 2 mm Ø 180 mm bocht 30°	48,00	A
1502070	Zwart 2 mm Ø 180 mm bocht 45°	48,00	A
1502080	Zwart 2 mm Ø 180 mm bocht 90°	48,00	A
1502090	Zwart 2 mm Ø 180 mm bocht 45°+ luik	57,60	A
1502100	Zwart 2 mm Ø 180 mm bocht 90°+ luik	57,60	A
1502110	Zwart 2 mm Ø 180 mm bocht verstelbaar + luik	65,60	A
1502120	Zwart 2 mm Ø 180 mm rozet	18,60	A
1502130	Zwart 2 mm Ø 180 mm muurbeugel	30,40	A



ROOKGASKANALEN

Enkelwandig Dikwandig 2 mm staal Kachel/Open Haardkanaal

Zwart 2 mm
 Ø 200 mm



Artikelnr.	Omschrijving	Brutoprijs	Krt.G
1502200	Zwart 2 mm Ø 200 mm pijp L = 1000 mm	62,10	A
1502210	Zwart 2 mm Ø 200 mm pijp L = 750 mm	60,30	A
1502220	Zwart 2 mm Ø 200 mm pijp L = 500 mm	53,50	A
1502230	Zwart 2 mm Ø 200 mm pijp L = 500 mm + klep	66,30	A
1502240	Zwart 2 mm Ø 200 mm pijp L = 250 mm	30,40	A
1502250	Zwart 2 mm Ø 200 mm pasijp L = 400 mm	44,40	A
1502260	Zwart 2 mm Ø 200 mm bocht 30°	55,40	A
1502270	Zwart 2 mm Ø 200 mm bocht 45°	55,40	A
1502280	Zwart 2 mm Ø 200 mm bocht 90°	55,40	A
1502290	Zwart 2 mm Ø 200 mm bocht 45°+ luik	67,30	A
1502300	Zwart 2 mm Ø 200 mm bocht 90°+ luik	67,30	A
1502310	Zwart 2 mm Ø 200 mm bocht verstelbaar + luik	77,70	A
1502320	Zwart 2 mm Ø 200 mm rozet	26,20	A
1502330	Zwart 2 mm Ø 200 mm muurbeugel	31,90	A

Zwart 2 mm
 Ø 250 mm



1502400	Zwart 2 mm Ø 250 mm pijp L = 1000 mm	74,40	A
1502410	Zwart 2 mm Ø 250 mm pijp L = 750 mm	69,40	A
1502420	Zwart 2 mm Ø 250 mm pijp L = 500 mm	48,60	A
1502430	Zwart 2 mm Ø 250 mm pijp L = 500 mm + klep	71,60	A
1502440	Zwart 2 mm Ø 250 mm pijp L = 250 mm	33,90	A
1502450	Zwart 2 mm Ø 250 mm pasijp L = 400 mm	49,50	A
1502460	Zwart 2 mm Ø 250 mm bocht 45°	58,80	A
1502470	Zwart 2 mm Ø 250 mm bocht 90°	58,80	A
1502480	Zwart 2 mm Ø 250 mm rozet	28,20	A

Zwart 2 mm
 Verlopen



1502500	Zwart 2 mm verloop Ø 118 - 126 mm	48,40	A
1502510	Zwart 2 mm verloop Ø 118 - 130 mm	48,40	A
1502520	Zwart 2 mm verloop Ø 118 - 150 mm	48,40	A
1502530	Zwart 2 mm verloop Ø 122 - 130 mm	48,40	A
1502540	Zwart 2 mm verloop Ø 127 - 150 mm	48,40	A
1502550	Zwart 2 mm verloop Ø 148 - 180 mm	50,30	A
1502560	Zwart 2 mm verloop Ø 148 - 200 mm	51,80	A
1502570	Zwart 2 mm verloop Ø 158 - 180 mm	50,30	A
1502580	Zwart 2 mm verloop Ø 177 - 200 mm	51,80	A

* Antraciet verlopen niet leverbaar



ROOKGASKANALEN

Enkelwandig blank RVS Pelletkachelkanaal

RVS Ø 80 mm



Artikelnr.	Omschrijving	Brutoprijs	Krt.G
1212000	RVS blank Ø 80 mm pijp L=1000 mm	34,00	A
1212010	RVS blank Ø 80 mm pijp L=500 mm	25,50	A
1212020	RVS blank Ø 80 mm pijp L=250 mm	21,00	A
1212130	RVS blank Ø 80 mm paspijp 330 mm	22,60	A
1212030	RVS blank Ø 80 mm bocht 30°	24,60	A
1212040	RVS blank Ø 80 mm bocht 45°	25,70	A
1212050	RVS blank Ø 80 mm bocht 90°	28,00	A
1212060	RVS blank Ø 80 mm T-stuk 90°	55,60	A
1212070	RVS blank Ø 80 mm T-stuk 90° M/M/S	62,80	A
1212080	RVS blank Ø 80 mm dop voor T-stuk	18,80	A
1212090	RVS blank Ø 80 mm dop met condensafvoer	21,10	A
1212100	RVS blank Ø 80 mm muurbeugel	34,50	A
1212110	RVS blank Ø 80 mm mof	16,60	A
1212120	RVS blank Ø 80 mm trekkap	62,70	A
1411150	RVS blank Ø 80 mm stormkraag	12,50	A
1212150	RVS blank Ø 80 mm rozet	33,80	A
1411300	RVS blank vergrotend verloop Ø 80 - 100 mm	48,80	A
1400695	RVS blank geveldoorvoer EW Ø 80 mm	144,50	A
1212455	RVS zwart geveldoorvoer EW Ø 80 mm	157,50	A

RVS Ø 100 mm



1212200	RVS blank Ø 100 mm pijp L=1000 mm	42,50	A
1212210	RVS blank Ø 100 mm pijp L=500 mm	29,30	A
1212220	RVS blank Ø 100 mm pijp L=250 mm	26,00	A
1212230	RVS blank Ø 100 mm paspijp 330 mm	28,00	A
1212240	RVS blank Ø 100 mm bocht 30°	30,60	A
1212250	RVS blank Ø 100 mm bocht 45°	32,20	A
1212260	RVS blank Ø 100 mm bocht 90°	35,40	A
1212270	RVS blank Ø 100 mm T-stuk 90°	60,00	A
1212280	RVS blank Ø 100 mm dop voor T-stuk	21,10	A
1212290	RVS blank Ø 100 mm dop met condensafvoer	23,30	A
1212300	RVS blank Ø 100 mm muurbeugel	39,90	A
1212310	RVS blank Ø 100 mm trekkap	69,30	A
1212330	RVS blank Ø 100 mm mof	21,10	A
1411350	RVS blank Ø 100 mm stormkraag	14,40	A
1212350	RVS blank Ø 100 mm rozet	34,60	A
1411300	RVS blank vergrotend verloop Ø 80 - 100 mm	48,80	A

Alle componenten worden geleverd met siliconenring



ROOKGASKANALEN

Enkelwandig zwart geëmailleerd en RVS Pelletkachelkanaal

Zwart Ø 80 mm
Living Pellet
met lippenring



Artikelnr.	Omschrijving	Brutoprijs	Krt.G
1213000	Zwart Living Pellet Ø 80 mm pijp L = 1500 mm	46,20	A
1213010	Zwart Living Pellet Ø 80 mm pijp L = 1000 mm	27,90	A
1213020	Zwart Living Pellet Ø 80 mm pijp L = 500 mm	19,60	A
1213030	Zwart Living Pellet Ø 80 mm pijp L = 250 mm	18,40	A
1213040	Zwart Living Pellet Ø 80 mm bocht 45°	30,40	A
1213050	Zwart Living Pellet Ø 80 mm bocht 90°	32,00	A
1213060	Zwart Living Pellet Ø 80 mm bocht 90° met inspectieluik	45,90	A
1213070	Zwart Living Pellet Ø 80 mm T-stuk mof/spie/spie + dop	53,60	A
1213080	Zwart Living Pellet Ø 80 mm T-stuk mof/mof/spie + dop	60,80	A
1213090	Zwart Living Pellet Ø 80 mm vergr. verloop Ø 80-100 mm	48,50	A
1213100	Zwart Living Pellet Ø 80 mm mof M/M	21,20	A
1213110	Zwart Living Pellet Ø 80 mm mof S/S	21,20	A
1213120	Zwart Living Pellet Ø 80 mm rozet	16,60	A
1213130	Zwart Living Pellet Ø 80 mm nisbus	45,40	A
1213140	Zwart Living Pellet Ø 80 mm eindkap	63,90	A
1213150	Zwart Living Pellet Ø 80 mm muurbeugel	13,40	A
1213035	Zwart Living Pellet Ø 80 mm paspijp L = 410 - 610 mm	59,00	A

Zwart Ø 100 mm
Living Pellet
met lippenring



1213200	Zwart Living Pellet Ø 100 mm pijp L = 1500 mm	52,20	A
1213210	Zwart Living Pellet Ø 100 mm pijp L = 1000 mm	30,40	A
1213220	Zwart Living Pellet Ø 100 mm pijp L = 500 mm	20,60	A
1213230	Zwart Living Pellet Ø 100 mm pijp L = 250 mm	19,60	A
1213240	Zwart Living Pellet Ø 100 mm bocht 45°	36,10	A
1213250	Zwart Living Pellet Ø 100 mm bocht 90°	39,70	A
1213260	Zwart Living Pellet Ø 100 mm bocht 90° met inspectieluik	51,00	A
1213270	Zwart Living Pellet Ø 100 mm T-stuk mof/spie/spie + dop	67,80	A
1213280	Zwart Living Pellet Ø 100 mm T-stuk mof/mof/spie + dop	67,80	A
1213290	Zwart Living Pellet Ø 100 mm verkl. verloop Ø 100-80 mm	48,50	A
1213300	Zwart Living Pellet Ø 100 mm mof M/M	23,20	A
1213310	Zwart Living Pellet Ø 100 mm mof S/S	23,20	A
1213320	Zwart Living Pellet Ø 100 mm rozet	18,30	A
1213330	Zwart Living Pellet Ø 100 mm nisbus	48,50	A
1213340	Zwart Living Pellet Ø 100 mm eindkap	70,10	A
1213350	Zwart Living Pellet Ø 100 mm muurbeugel	16,00	A
1213235	Zwart Living Pellet Ø 100 mm paspijp L = 410 - 610 mm	65,90	A

Zwart Ø 80 mm
RVS
met lippenring



1212400	Zwart RVS Ø 80 mm pijp L = 1000 mm	52,20	A
1212410	Zwart RVS Ø 80 mm pijp L = 500 mm	41,90	A
1212420	Zwart RVS Ø 80 mm pijp L = 250 mm	34,30	A
1212465	Zwart RVS Ø 80 mm paspijp L = 330 mm	35,80	A
1212430	Zwart RVS Ø 80 mm bocht 90°	39,10	A
1212440	Zwart RVS Ø 80 mm bocht 45°	37,00	A
1212450	Zwart RVS Ø 80 mm bocht 30°	35,80	A
1212415	Zwart RVS Ø 80 mm T-stuk M/M/S	77,50	A
1212470	Zwart RVS Ø 80 mm T-stuk M/S/S	68,90	A
1212425	Zwart RVS Ø 80 mm condensdop	31,70	A
1212435	Zwart RVS Ø 80 mm dop	29,50	A
1212480	Zwart RVS Ø 80 mm rozet	40,20	A
1212405	Zwart RVS Ø 80 mm mof M/M	28,00	A
1212445	Zwart RVS Ø 80 mm trekkende kap	76,70	A
1212455	Zwart RVS Ø 80 mm geveldoorsvoer EW	167,30	A
1212495	Zwart RVS Ø 80 mm muurbeugel	42,10	A

SCHIEDEL LIVING PELLET



Toepassing:	Design rookgaskanaal voor Pelletkachels
Brandstoffen:	Vaste brandstof
Diameters:	Ø 80 mm en Ø 100 mm
Materiaal:	1,2 mm Smeedijzer
Afwerking	Mat zwart, hoge temperatuur bestendig
Prestaties:	Temperatuur $\leq 200^{\circ}\text{C}$ Corrosiebestendig: Vm Druk negatief ($N1 \leq 40 \text{ Pa}$) zonder ring Druk positief ($P1 \leq 200 \text{ Pa}$) met ring Compleet pakket, zie Pag: 43



ROOKGASKANALEN

Enkelwandig RVS Kanaal Prima Plus Rite Vent - Schiedel

RVS Ø 130 mm
met mogelijkheid
voor lipring



Artikelnr.	Omschrijving	Brutoprijs	Krt.G
1220122	Prima Plus RVS Ø 130 mm pijp L = 1000 mm	46,60	A
1220220	Prima Plus RVS Ø 130 mm pijp L= 500 mm	25,70	A
1220320	Prima Plus RVS Ø 130 mm pijp L= 250 mm	16,70	A
1220420	Prima Plus RVS Ø 130 mm paspijp 270 - 415 mm	42,90	A
1220520	Prima Plus RVS Ø 130 mm bocht 90°	54,90	A
1220620	Prima Plus RVS Ø 130 mm bocht 85°	54,90	A
1220720	Prima Plus RVS Ø 130 mm bocht 45°	39,10	A
1220820	Prima Plus RVS Ø 130 mm bocht 30°	39,10	A
1220920	Prima Plus RVS Ø 130 mm bocht 15°	39,10	A
1221000	Prima Plus RVS Ø 130 mm instelbare bocht 0 -90° tot 600 C	59,00	A
1221122	Prima Plus RVS Ø 130 mm T-stuk 90°	60,90	A
1221220	Prima Plus RVS Ø 130 mm T-stuk 45°	96,50	A
1221310	Prima Plus RVS Ø 130 mm T-stuk 90° spruit 80 mm	73,10	A
1221520	Prima Plus RVS Ø 130 mm dop met aftap	34,50	A
1221620	Prima Plus RVS Ø 130 mm verdieping tussensteun	52,10	A
1221820	Prima Plus RVS Ø 130 mm trekkende kap	65,80	A
1101200	Prima Plus RVS Ø 130 mm stormkraag	35,30	A
1222020	Prima Plus RVS Ø 130 mm muurbeugel	21,50	A
1222120	Prima Plus RVS Ø 130 mm klemband	10,80	A
1222420	Prima Plus RVS Ø 130 mm ketelaansluiting	28,40	A
1222520	Prima Plus RVS Ø 130 mm lipring	7,10	A
1222620	Prima Plus RVS Ø 130 mm dakplaat platdak	74,10	A
1222710	Prima Plus RVS Ø 130 mm gaasroosterdop	86,00	A

RVS Ø 150 mm
met mogelijkheid
voor lipring



1220130	Prima Plus RVS Ø 150 mm pijp L= 1000 mm	52,80	A
1220230	Prima Plus RVS Ø 150 mm pijp L= 500 mm	29,10	A
1220330	Prima Plus RVS Ø 150 mm pijp L= 250 mm	18,90	A
1220430	Prima Plus RVS Ø 150 mm paspijp 270 - 415 mm	45,40	A
1220530	Prima Plus RVS Ø 150 mm bocht 90°	62,20	A
1220630	Prima Plus RVS Ø 150 mm bocht 85°	62,20	A
1220730	Prima Plus RVS Ø 150 mm bocht 45°	44,60	A
1220830	Prima Plus RVS Ø 150 mm bocht 30°	44,60	A
1220930	Prima Plus RVS Ø 150 mm bocht 15°	44,60	A
1221010	Prima Plus RVS Ø 150 mm instelbare bocht 0 -90° tot 600 C	66,20	A
1221130	Prima Plus RVS Ø 150 mm T-stuk 90°	70,60	A
1221230	Prima Plus RVS Ø 150 mm T-stuk 45°	99,30	A
1221320	Prima Plus RVS Ø 150 mm T-stuk 90° spruit 80 mm	76,50	A
1221530	Prima Plus RVS Ø 150 mm dop met aftap	36,10	A
1221630	Prima Plus RVS Ø 150 mm verdieping tussensteun	53,60	A
1221830	Prima Plus RVS Ø 150 mm trekkende kap	72,00	A
1101210	Prima Plus RVS Ø 150 mm stormkraag	36,10	A
1222030	Prima Plus RVS Ø 150 mm muurbeugel	22,10	A
1222130	Prima Plus RVS Ø 150 mm klemband	10,80	A
1222430	Prima Plus RVS Ø 150 mm ketelaansluiting	30,10	A
1222530	Prima Plus RVS Ø 150 mm lipring	7,10	A
1222630	Prima Plus RVS Ø 150 mm dakplaat platdak	74,10	A
1222720	Prima Plus RVS Ø 150 mm gaasroosterdop	97,10	A

* Prima Plus componenten zijn geprijsd zonder lipring

* Prima Plus is geen voorraadartikel

SCHIEDEL

ROOKGASKANALEN

Enkelwandig RVS Kanaal Prima Plus Rite Vent - Schiedel

RVS Ø 180 mm
 met mogelijkheid
 voor lipring



Artikelnr.	Omschrijving	Brutoprijs	Krt.G
1220140	Prima plus RVS Ø 180 mm pijp L = 1000 mm	62,10	A
1220240	Prima plus RVS Ø 180 mm pijp L = 500 mm	34,20	A
1220340	Prima plus RVS Ø 180 mm pijp L = 250 mm	22,40	A
1220440	Prima plus RVS Ø 180 mm paspijp 270 - 415 mm	50,10	A
1220540	Prima plus RVS Ø 180 mm bocht 90°	67,20	A
1220640	Prima plus RVS Ø 180 mm bocht 85°	67,20	A
1220740	Prima plus RVS Ø 180 mm bocht 45°	47,90	A
1220840	Prima plus RVS Ø 180 mm bocht 30°	47,90	A
1220940	Prima plus RVS Ø 180 mm bocht 15°	47,90	A
1221020	Prima plus RVS Ø 180 mm instelbare bocht 0 -90° tot 600 C	87,40	A
1221140	Prima plus RVS Ø 180 mm T-stuk 90°	87,40	A
1221240	Prima plus RVS Ø 180 mm T-stuk 45°	119,30	A
1221330	Prima plus RVS Ø 180 mm T-stuk 90° spruit 80 mm	84,00	A
1221540	Prima plus RVS Ø 180 mm dop met aftap	40,10	A
1221640	Prima plus RVS Ø 180 mm verdieping tussensteun	55,20	A
1221831	Prima plus RVS Ø 180 mm trekkende kap	81,10	A
1101220	Prima plus RVS Ø 180 mm stormkraag	39,30	A
1222040	Prima plus RVS Ø 180 mm muurbeugel	24,80	A
1222140	Prima plus RVS Ø 180 mm klemband	12,10	A
1222440	Prima plus RVS Ø 180 mm ketelaansluiting	30,50	A
1222540	Prima plus RVS Ø 180 mm lipring	8,80	A
1222640	Prima plus RVS Ø 180 mm dakplaat platdak	74,10	A
1222730	Prima plus RVS Ø 180 mm gaasroosterdop	98,20	A

RVS Ø 200 mm
 met mogelijkheid
 voor lipring



1220150	Prima plus RVS Ø 200 mm pijp L = 1000 mm	66,90	A
1220250	Prima plus RVS Ø 200 mm pijp L = 500 mm	36,70	A
1220350	Prima plus RVS Ø 200 mm pijp L = 250 mm	24,00	A
1220450	Prima plus RVS Ø 200 mm paspijp 270 - 415 mm	54,20	A
1220550	Prima plus RVS Ø 200 mm bocht 90°	73,50	A
1220650	Prima plus RVS Ø 200 mm bocht 85°	52,30	A
1220750	Prima plus RVS Ø 200 mm bocht 45°	52,30	A
1220850	Prima plus RVS Ø 200 mm bocht 30°	52,30	A
1220950	Prima plus RVS Ø 200 mm bocht 15°	52,30	A
1221030	Prima plus RVS Ø 200 mm instelbare bocht 0 -90° tot 600 C	77,60	A
1221150	Prima plus RVS Ø 200 mm T-stuk 90°	100,60	A
1221250	Prima plus RVS Ø 200 mm T-stuk 45°	132,60	A
1221340	Prima plus RVS Ø 200 mm T-stuk 90° spruit 80 mm	91,80	A
1221550	Prima plus RVS Ø 200 mm dop met aftap	45,30	A
1221650	Prima plus RVS Ø 200 mm verdieping tussensteun	57,40	A
1221832	Prima plus RVS Ø 200 mm trekkende kap	87,70	A
1101230	Prima plus RVS Ø 200 mm stormkraag	43,00	A
1222050	Prima plus RVS Ø 200 mm muurbeugel	26,20	A
1222150	Prima plus RVS Ø 200 mm klemband	12,10	A
1222450	Prima plus RVS Ø 200 mm ketelaansluiting	51,20	A
1222550	Prima plus RVS Ø 200 mm lipring	8,80	A
1222650	Prima plus RVS Ø 200 mm dakplaat platdak	74,10	A
1222740	Prima plus RVS Ø 200 mm gaasroosterdop	104,80	A

* Prima plus componenten zijn geprijsd zonder lipring

* **Prima Plus is geen voorraadartikel**

SCHIEDEL



ROOKGASKANALEN

Enkelwandig RVS Kanaal Prima Plus Rite Vent - Schiedel

RVS Ø 250 mm
met mogelijkheid
voor lipring



Artikelnr.	Omschrijving	Brutoprijs	krt.G
1220160	Prima plus RVS Ø 250 mm pijp L = 1000 mm	79,00	A
1220260	Prima plus RVS Ø 250 mm pijp L = 500 mm	43,50	A
1220360	Prima plus RVS Ø 250 mm pijp L = 250 mm	28,40	A
1220460	Prima plus RVS Ø 250 mm paspijp 270 - 415 mm	62,50	A
1220560	Prima plus RVS Ø 250 mm bocht 90°	84,70	A
1220660	Prima plus RVS Ø 250 mm bocht 85°	84,70	A
1220760	Prima plus RVS Ø 250 mm bocht 45°	60,50	A
1220860	Prima plus RVS Ø 250 mm bocht 30°	60,50	A
1220960	Prima plus RVS Ø 250 mm bocht 15°	60,50	A
1221040	Prima plus RVS Ø 250 mm instelbare bocht 0 -90° tot 600 C	94,20	A
1221160	Prima plus RVS Ø 250 mm T-stuk 90°	177,50	A
1221260	Prima plus RVS Ø 250 mm T-stuk 45°	165,60	A
1221350	Prima plus RVS Ø 250 mm T-stuk 90° spruit 80 mm	94,00	A
1221560	Prima plus RVS Ø 250 mm dop met aftap	56,70	A
1221660	Prima plus RVS Ø 250 mm verdieping tussensteun	64,20	A
1221833	Prima plus RVS Ø 250 mm trekkende kap	122,60	A
1101250	Prima plus RVS Ø 250 mm stormkraag	46,90	A
1222060	Prima plus RVS Ø 250 mm muurbeugel	26,80	A
1222160	Prima plus RVS Ø 250 mm klemband	14,30	A
1222460	Prima plus RVS Ø 250 mm ketelaansluiting	56,50	A
1222560	Prima plus RVS Ø 250 mm lipring	15,30	A
1222660	Prima plus RVS Ø 250 mm dakplaat platdak	74,10	A
1222750	Prima plus RVS Ø 250 mm gaasroosterdop	112,50	A

RVS Ø 300 mm
met mogelijkheid
voor lipring



1220170	Prima plus RVS Ø 300 mm pijp L = 1000 mm	103,70	A
1220270	Prima plus RVS Ø 300 mm pijp L = 500 mm	57,20	A
1220370	Prima plus RVS Ø 300 mm pijp L = 250 mm	37,20	A
1220470	Prima plus RVS Ø 300 mm paspijp 270 - 415 mm	72,00	A
1220570	Prima plus RVS Ø 300 mm bocht 90°	90,20	A
1220670	Prima plus RVS Ø 300 mm bocht 85°	90,20	A
1220770	Prima plus RVS Ø 300 mm bocht 45°	64,40	A
1220870	Prima plus RVS Ø 300 mm bocht 30°	64,40	A
1220970	Prima plus RVS Ø 300 mm bocht 15°	64,40	A
1221170	Prima plus RVS Ø 300 mm T-stuk 90°	209,90	A
1221270	Prima plus RVS Ø 300 mm T-stuk 45°	198,80	A
1221360	Prima plus RVS Ø 300 mm T-stuk 90° spruit 80 mm	100,40	A
1221570	Prima plus RVS Ø 300 mm dop met aftap	64,50	A
1221670	Prima plus RVS Ø 300 mm verdieping tussensteun	76,10	A
1221834	Prima plus RVS Ø 300 mm trekkende kap	146,30	A
1101260	Prima plus RVS Ø 300 mm stormkraag	53,40	A
1222070	Prima plus RVS Ø 300 mm muurbeugel	28,10	A
1222170	Prima plus RVS Ø 300 mm klemband	20,60	A
1222470	Prima plus RVS Ø 300 mm ketelaansluiting	59,80	A
1222570	Prima plus RVS Ø 300 mm lipring	17,50	A
1222670	Prima plus RVS Ø 300 mm dakplaat platdak	99,20	A
1222760	Prima plus RVS Ø 300 mm gaasroosterdop	116,90	A

* Prima plus componenten zijn geprijsd zonder lipring

* **Prima Plus is geen voorraadartikel**

SCHIEDEL

ROOKGASKANALEN

Enkelwandig RVS kanaal Prima plus Rite Vent - Schiedel

RVS Ø 350 mm
met mogelijkheid
voor lipring



Artikelnr.	Omschrijving	Brutoprijs	kr.G
1220180	Prima plus RVS Ø 350 mm pijp L = 1000 mm	147,40	A
1220280	Prima plus RVS Ø 350 mm pijp L = 500 mm	108,80	A
1220380	Prima plus RVS Ø 350 mm pijp L = 250 mm	81,30	A
1220480	Prima plus RVS Ø 350 mm paspijp 270- 415 mm	121,70	A
1220580	Prima plus RVS Ø 350 mm bocht 90°	160,30	A
1220680	Prima plus RVS Ø 350 mm bocht 85°	96,20	A
1220780	Prima plus RVS Ø 350 mm bocht 45°	68,80	A
1220880	Prima plus RVS Ø 350 mm bocht 30°	68,80	A
1220980	Prima plus RVS Ø 350 mm bocht 15°	68,80	A
1221180	Prima plus RVS Ø 350 mm T-stuk 90°	229,40	A
1221280	Prima plus RVS Ø 350 mm T-stuk 45°	232,00	A
1221370	Prima plus RVS Ø 350 mm T-stuk 90° spruit 80 mm	100,40	A
1221580	Prima plus RVS Ø 350 mm dop met aftap	69,30	A
1221680	Prima plus RVS Ø 350 mm verdieping tussensteun	84,70	A
1221835	Prima plus RVS Ø 350 mm trekkende kap	167,70	A
1101270	Prima plus RVS Ø 350 mm stormkraag	58,00	A
1222080	Prima plus RVS Ø 350 mm muurbeugel	28,10	A
1222180	Prima plus RVS Ø 350 mm klemband	20,60	A
1222480	Prima plus RVS Ø 350 mm ketelaansluiting	67,50	A
1222580	Prima plus RVS Ø 350 mm lipring	21,30	A
1222680	Prima plus RVS Ø 350 mm dakplaat platdak	118,00	A
1222770	Prima plus RVS Ø 350 mm gaasroosterdop	136,80	A

RVS verlopen
met mogelijkheid
voor lipring
Vergrotend



1222200	Prima Plus RVS verloop Ø 80 - 130 mm vergrotend	33,60	A
1222210	Prima Plus RVS verloop Ø100 - 130 mm vergrotend	34,20	A
1222220	Prima Plus RVS verloop Ø100 - 150 mm vergrotend	39,90	A
1222230	Prima Plus RVS verloop Ø130 - 150 mm vergrotend	39,90	A
1222240	Prima Plus RVS verloop Ø130 - 180 mm vergrotend	48,10	A
1222250	Prima Plus RVS verloop Ø150 - 180 mm vergrotend	48,10	A
1222260	Prima Plus RVS verloop Ø150 - 200 mm vergrotend	49,90	A
1222270	Prima Plus RVS verloop Ø180 - 200 mm vergrotend	49,90	A
1222280	Prima Plus RVS verloop Ø180 - 250 mm vergrotend	59,80	A
1222290	Prima Plus RVS verloop Ø200 - 250 mm vergrotend	59,80	A
1222295	Prima Plus RVS verloop Ø250 - 300 mm vergrotend	79,30	A

RVS verlopen
met mogelijkheid
voor lipring
Verkleinend



1222300	Prima Plus RVS verloop Ø130 - 100 mm verkleinend	45,50	A
1222310	Prima Plus RVS verloop Ø180 - 130 mm verkleinend	45,50	A
1222320	Prima Plus RVS verloop Ø180 - 150 mm verkleinend	45,50	A
1222330	Prima Plus RVS verloop Ø200 - 150 mm verkleinend	45,50	A
1222340	Prima Plus RVS verloop Ø200 - 180 mm verkleinend	59,80	A
1222350	Prima Plus RVS verloop Ø250 - 180 mm verkleinend	59,80	A
1222360	Prima Plus RVS verloop Ø250 - 200 mm verkleinend	59,80	A
1222370	Prima Plus RVS verloop Ø300 - 250 mm verkleinend	79,30	A

* Prima Plus componenten zijn geprijsd zonder lipring

* **Prima Plus is geen voorraadartikel**

SCHIEDEL



ROOKGASKANALEN

Enkelwandig RVS Kanaal ME met lipring

ME RVS
 Ø 80 mm



Artikelnr.	Omschrijving	Brutoprijs	Krt.G
1411000	ME RVS Ø 80 mm pijp L = 1000 mm	38,10	A
1411010	ME RVS Ø 80 mm pijp L = 500 mm	29,90	A
1411020	ME RVS Ø 80 mm pijp L = 250 mm	22,90	A
1411030	ME RVS Ø 80 mm pijp L = 150 mm	22,90	A
1411040	ME RVS Ø 80 mm bocht 87°	36,90	A
1411050	ME RVS Ø 80 mm bocht 45°	31,70	A
1411060	ME RVS Ø 80 mm bocht 30°	31,70	A
1411070	ME RVS Ø 80 mm bocht 15°	31,70	A
1411080	ME RVS Ø 80 mm paspijp 200-300 mm	58,00	A
1411090	ME RVS Ø 80 mm T-stuk 87°	59,70	A
1411100	ME RVS Ø 80 mm T-stuk 90°	59,70	A
1411105	ME RVS Ø 80 mm dop voor T-stuk	35,30	A
1411110	ME RVS Ø 80 mm condensdop 3/4"	33,40	A
1411120	ME RVS Ø 80 mm condensafvoer horizontaal	52,70	A
1411130	ME RVS Ø 80 mm klemband	9,00	A
1411140	ME RVS Ø 80 mm muurbeugel 25-90	36,90	A
1411150	ME RVS Ø 80 mm stormkraag	12,40	A
1411160	ME RVS Ø 80 mm trekkende kap	84,40	A
1411300	ME RVS vergrotend verloop Ø 80-100	48,40	A

ME RVS
 Ø 100 mm



1411200	ME RVS Ø 100 mm pijp L = 1000 mm	41,80	A
1411210	ME RVS Ø 100 mm pijp L = 500 mm	29,90	A
1411220	ME RVS Ø 100 mm pijp L = 250 mm	24,80	A
1411230	ME RVS Ø 100 mm pijp L = 150 mm	24,80	A
1411240	ME RVS Ø 100 mm bocht 87°	45,70	A
1411250	ME RVS Ø 100 mm bocht 45°	35,30	A
1411260	ME RVS Ø 100 mm bocht 30°	35,30	A
1411270	ME RVS Ø 100 mm bocht 15°	35,30	A
1411280	ME RVS Ø 100 mm paspijp 200-300 mm	59,70	A
1411290	ME RVS Ø 100 mm T-stuk 87°	61,60	A
1411303	ME RVS Ø 100 mm T-stuk 90°	61,60	A
1411380	ME RVS Ø 100 mm T-stuk 45°	136,80	A
1411305	ME RVS Ø 100 mm dop voor T-stuk	42,30	A
1411310	ME RVS Ø 100 mm condensdop 3/4"	37,00	A
1411320	ME RVS Ø 100 mm condensafvoer horizontaal	64,90	A
1411330	ME RVS Ø 100 mm klemband	9,00	A
1411340	ME RVS Ø 100 mm muurbeugel 25-90 mm	36,90	A
1411350	ME RVS Ø 100 mm stormkraag	14,30	A
1411360	ME RVS Ø 100 mm trekkende kap	86,10	A
1411365	ME RVS Ø 100 mm trekkende kap met topgaas	112,40	A
1411370	ME RVS Ø 100 mm T-stuk 87° spruit Ø 80 mm	62,70	A
1411300	ME RVS vergrotend verloop Ø 80-100	48,40	A



ROOKGASKANALEN

Enkelwandig RVS Kanaal ME met lipring

ME RVS
 Ø 113 mm



Artikelnr.	Omschrijving	Brutoprijs	Krt.G
1212700	ME RVS Ø 113 mm pijp L = 1000 mm	47,40	A
1212710	ME RVS Ø 113 mm pijp L = 500 mm	31,90	A
1212720	ME RVS Ø 113 mm pijp L = 250 mm	26,50	A
1212725	ME RVS Ø 113 mm pijp L = 150 mm	26,50	A
1212738	ME RVS Ø 113 mm bocht 87°	47,40	A
1212736	ME RVS Ø 113 mm bocht 45°	42,20	A
1212734	ME RVS Ø 113 mm bocht 30°	42,20	A
1212732	ME RVS Ø 113 mm bocht 15°	42,20	A
1212730	ME RVS Ø 113 mm paspijp 200-300 mm	61,60	A
1212770	ME RVS Ø 113 mm T-stuk 87°	70,30	A
1212774	ME RVS Ø 113 mm T-stuk 90°	70,30	A
1212775	ME RVS Ø 113 mm T-stuk 45°	149,30	A
1212785	ME RVS Ø 113 mm dop voor T-stuk	45,80	A
1212745	ME RVS Ø 113 mm condensdop 3/4"	40,40	A
1212746	ME RVS Ø 113 mm condensafvoer horizontaal	76,40	A
1212748	ME RVS Ø 113 mm condensafvoer zijwaarts	100,10	A
1212750	ME RVS Ø 113 mm klemband	9,00	A
1212755	ME RVS Ø 113 mm muurbeugel 25-90 mm	37,00	A
1212760	ME RVS Ø 113 mm stormkraag	16,00	A
1212780	ME RVS Ø 113 mm trekkende kap	89,70	A
1212765	ME RVS Ø 113 mm trekkende kap met topgaas	125,10	A
1212740	ME RVS Ø 113 mm T-stuk 87° spruit Ø 80 mm	70,30	A
1212790	ME RVS vergroterend verloop Ø 113 mm (< Ø opgeven)	58,00	A

ME RVS
 Ø 130 mm



1410015	ME RVS Ø 130 mm pijp L = 1000 mm	53,00	A
1410065	ME RVS Ø 130 mm pijp L = 500 mm	35,30	A
1411420	ME RVS Ø 130 mm pijp L = 250 mm	28,30	A
1411430	ME RVS Ø 130 mm pijp L = 150 mm	28,30	A
1410045	ME RVS Ø 130 mm bocht 87°	49,30	A
1410035	ME RVS Ø 130 mm bocht 45°	44,00	A
1411460	ME RVS Ø 130 mm bocht 30°	44,00	A
1411470	ME RVS Ø 130 mm bocht 15°	44,00	A
1411480	ME RVS Ø 130 mm paspijp 200-300 mm	63,30	A
1411490	ME RVS Ø 130 mm T-stuk 87°	75,50	A
1411500	ME RVS Ø 130 mm T-stuk 90°	75,50	A
1411590	ME RVS Ø 130 mm T-stuk 45°	161,30	A
1411510	ME RVS Ø 130 mm dop voor T-stuk	49,20	A
1411520	ME RVS Ø 130 mm condensdop 3/4"	45,70	A
1411530	ME RVS Ø 130 mm condensafvoer horizontaal	69,40	A
1411540	ME RVS Ø 130 mm klemband	9,00	A
1411550	ME RVS Ø 130 mm muurbeugel 25-90 mm	37,00	A
1411560	ME RVS Ø 130 mm stormkraag	17,70	A
1411570	ME RVS Ø 130 mm trekkende kap	100,10	A
1411575	ME RVS Ø 130 mm trekkende kap met topgaas	145,50	A
1411580	ME RVS Ø 130 mm T-stuk 87° spruit Ø 80 mm	75,50	A
1411595	ME RVS vergroterend verloop Ø 130 mm (< Ø opgeven)	54,50	A



ROOKGASKANALEN

Enkelwandig RVS Kanaal ME met lipring

ME RVS
 Ø 150 mm



Artikelnr.	Omschrijving	Brutoprijs	Krt.G
1410010	ME RVS Ø 150 mm pijp L = 1000 mm	60,70	A
1411610	ME RVS Ø 150 mm pijp L = 500 mm	38,80	A
1411620	ME RVS Ø 150 mm pijp L = 250 mm	31,80	A
1411630	ME RVS Ø 150 mm pijp L = 150 mm	31,80	A
1410040	ME RVS Ø 150 mm bocht 87°	56,30	A
1410030	ME RVS Ø 150 mm bocht 45°	45,70	A
1411660	ME RVS Ø 150 mm bocht 30°	45,70	A
1411670	ME RVS Ø 150 mm bocht 15°	45,70	A
1411680	ME RVS Ø 150 mm paspijp 200-300	66,70	A
1411690	ME RVS Ø 150 mm T-stuk 87°	82,60	A
1410060	ME RVS Ø 150 mm T-stuk 90°	82,60	A
1411790	ME RVS Ø 150 mm T-stuk 45°	175,30	A
1411710	ME RVS Ø 150 mm dop voor T-stuk	52,70	A
1411720	ME RVS Ø 150 mm condensdop 3/4"	49,30	A
1410080	ME RVS Ø 150 mm condensafvoer horizontaal	69,40	A
1411740	ME RVS Ø 150 mm klemband	9,00	A
1411750	ME RVS Ø 150 mm muurbeugel 25-90	38,80	A
1410070	ME RVS Ø 150 mm stormkraag	19,50	A
1411770	ME RVS Ø 150 mm trekkende kap	131,60	A
1411775	ME RVS Ø 150 mm trekkende kap met topgaas	150,80	A
1411780	ME RVS Ø 150 mm T-stuk 87° spruit Ø 80 mm	82,60	A
1411785	ME RVS Ø 150 mm schachtsteun MESZ	77,30	A
1411786	ME RVS Ø 150 mm band muurondersteuning MEMO	42,30	A
1411787	ME RVS Ø 150 mm set ondersteuning voor MEMO	38,80	A
1411795	ME RVS vergrotend verloop Ø 150 mm (< Ø opgeven)	69,40	A

ME RVS
 Ø 180 mm



1411800	ME RVS Ø 180 mm pijp L = 1000 mm	71,90	A
1411810	ME RVS Ø 180 mm pijp L = 500 mm	45,70	A
1411820	ME RVS Ø 180 mm pijp L = 250 mm	33,40	A
1411830	ME RVS Ø 180 mm pijp L = 150 mm	33,40	A
1411840	ME RVS Ø 180 mm bocht 87°	63,20	A
1411850	ME RVS Ø 180 mm bocht 45°	49,30	A
1411860	ME RVS Ø 180 mm bocht 30°	49,30	A
1411870	ME RVS Ø 180 mm bocht 15°	49,30	A
1411880	ME RVS Ø 180 mm paspijp 200-300 mm	73,80	A
1411890	ME RVS Ø 180 mm T-stuk 87°	98,30	A
1411900	ME RVS Ø 180 mm T-stuk 90°	98,30	A
1411990	ME RVS Ø 180 mm T-stuk 45°	191,20	A
1411910	ME RVS Ø 180 mm dop voor T-stuk	56,20	A
1411920	ME RVS Ø 180 mm condensdop 3/4"	52,70	A
1411930	ME RVS Ø 180 mm condensafvoer horizontaal	71,10	A
1411940	ME RVS Ø 180 mm klemband	9,00	A
1411950	ME RVS Ø 180 mm muurbeugel 25-90 mm	38,80	A
1411960	ME RVS Ø 180 mm stormkraag	21,30	A
1411970	ME RVS Ø 180 mm trekkende kap	150,80	A
1411975	ME RVS Ø 180 mm trekkende kap met topgaas	197,40	A
1411980	ME RVS Ø 180 mm T-stuk 87° spruit Ø 80 mm	98,20	A
1411995	ME RVS vergrotend verloop Ø 180 mm (< Ø opgeven)	71,10	A

SCHIEDEL METALOTERM

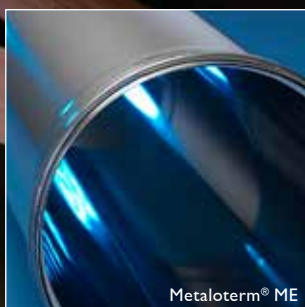
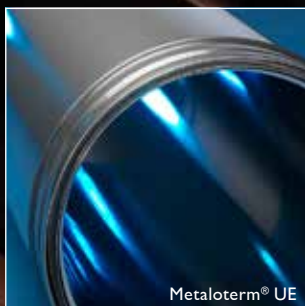

Metaloterm® UE

Voordelen van Metaloterm® UE

- Universeel toepasbaar rookgasafvoersysteem
- Aansluitbaar op Metaloterm® ME en Metaloterm® MF
- Overdrukdicht tot 5000 Pa
- Binnen- en buitenmantel van austenitisch roestvaststaal
- Thermische uitzetting wordt door het systeem opgevangen
- Extreem lage warmtemassa door geringe wanddikte
hetgeen de trek verbetert; langere leidinglengte mogelijk!

Metaloterm® ME

Voordelen van Metaloterm® ME

- Universeel toepasbaar
- Gas- en waterdicht systeem door unieke dichtring
- Aansluitbaar op Metaloterm® MF
- Vervaardigd van austenitisch roestvaststaal
- Thermische uitzetting wordt door het systeem opgevangen
- Lichtgewicht, geen zware constructie nodig
- Schoorsteenbrandbestendig

ROOKGASKANALEN

Enkelwandig RVS Kanaal ME met lipring

ME RVS
 Ø 200 mm



Artikelnr.	Omschrijving	Brutoprijs	Krt.G
1412000	ME RVS Ø 200 mm pijp L = 1000 mm	84,30	A
1412010	ME RVS Ø 200 mm pijp L = 500 mm	51,00	A
1412020	ME RVS Ø 200 mm pijp L = 250 mm	38,80	A
1412030	ME RVS Ø 200 mm pijp L = 150 mm	38,80	A
1412040	ME RVS Ø 200 mm bocht 87°	75,50	A
1412050	ME RVS Ø 200 mm bocht 45°	56,30	A
1412060	ME RVS Ø 200 mm bocht 30°	56,30	A
1412070	ME RVS Ø 200 mm bocht 15°	56,30	A
1412080	ME RVS Ø 200 mm paspijp 200-300 mm	80,90	A
1412090	ME RVS Ø 200 mm T-stuk 87°	115,90	A
1412100	ME RVS Ø 200 mm T-stuk 90°	115,90	A
1412190	ME RVS Ø 200 mm T-stuk 45°	211,70	A
1412110	ME RVS Ø 200 mm dop voor T-stuk	71,90	A
1412120	ME RVS Ø 200 mm condensdop 3/4"	56,30	A
1412130	ME RVS Ø 200 mm condensafvoer horizontaal	73,00	A
1412140	ME RVS Ø 200 mm klemband	9,00	A
1412150	ME RVS Ø 200 mm muurbeugel 25-90	38,80	A
1412155	ME RVS Ø 200 mm muurbeugel M8	24,00	A
1412160	ME RVS Ø 200 mm stormkraag	22,90	A
1412170	ME RVS Ø 200 mm trekkende kap	171,90	A
1412175	ME RVS Ø 200 mm trekkende kap met topgaas	204,80	A
1412180	ME RVS Ø 200 mm T-stuk 87° spruit Ø 80 mm	115,90	A
1412195	ME RVS vergrotend verloop Ø 200 mm (< Ø opgeven)	76,90	A

ME RVS
 Ø 250 mm



1410460	ME RVS Ø 250mm pijp L = 1000 mm	100,10	A
1412210	ME RVS Ø 250 mm pijp L = 500 mm	56,30	A
1410420	ME RVS Ø 250 mm pijp L = 250 mm	49,30	A
1412230	ME RVS Ø 250 mm pijp L = 150 mm	47,40	A
1412200	ME RVS Ø 250 mm paspijp 200-300 mm	91,50	A
1410440	ME RVS Ø 250 mm bocht 87°	98,30	A
1412250	ME RVS Ø 250 mm bocht 45°	64,90	A
1412260	ME RVS Ø 250 mm bocht 30°	64,90	A
1412270	ME RVS Ø 250 mm bocht 15°	64,90	A
1412290	ME RVS Ø 250 mm T-stuk 87°	135,20	A
1412300	ME RVS Ø 250 mm T-stuk 90°	135,20	A
1412390	ME RVS Ø 250 mm T-stuk 45°	249,00	A
1412310	ME RVS Ø 250 mm dop voor T-stuk	94,70	A
1412320	ME RVS Ø 250 mm condensdop 3/4"	63,30	A
1410450	ME RVS Ø 250 mm condensaftap Horizontaal	76,40	A
1410455	ME RVS Ø 250 mm condensaftap zijwaarts	138,80	A
1410480	ME RVS Ø 250 mm klemband	9,00	A
1412350	ME RVS Ø 250 mm muurbeugel 25-90	44,00	A
1410500	ME RVS Ø 250 mm stormkraag	24,80	A
1412370	ME RVS Ø 250 mm trekkende kap	207,00	A
1412375	ME RVS Ø 250 mm trekkende kap met topgaas	242,60	A
1412380	ME RVS Ø 250 mm T-stuk 87° spruit Ø 80 mm	135,10	A
1412395	ME RVS vergrotend verloop Ø 250 mm (< Ø opgeven)	89,60	A

ROOKGASKANALEN

Enkelwandig RVS Kanaal ME met lipring

ME RVS
 Ø 300 mm



Artikelnr.	Omschrijving	Brutoprijs	Krt.G
1412400	ME RVS Ø 300 mm pijp L = 1000 mm	120,10	A
1412410	ME RVS Ø 300 mm pijp L = 500 mm	90,10	A
1412420	ME RVS Ø 300 mm pijp L = 250 mm	65,50	A
1412423	ME RVS Ø 300 mm pijp L = 150 mm	63,70	A
1412440	ME RVS Ø 300 mm bocht 87°	136,00	A
1412450	ME RVS Ø 300 mm bocht 45°	87,70	A
1412460	ME RVS Ø 300 mm bocht 30°	88,40	A
1412470	ME RVS Ø 300 mm bocht 15°	88,40	A
1412480	ME RVS Ø 300 mm paspijp 200 - 300 mm	106,00	A
1412555	ME RVS Ø 300 mm T-stuk 87°	175,30	A
1412550	ME RVS Ø 300 mm T-stuk 90°	175,30	A
1412490	ME RVS Ø 300 mm T-stuk 45°	287,50	A
1412560	ME RVS Ø 300 mm dop voor T-stuk	108,80	A
1412374	ME RVS Ø 300 mm trekkende kap	250,60	A
1412376	ME RVS Ø 300 mm trekkende kap met topgaas	294,80	A
1412495	ME RVS Ø 300 mm muurbeugel 25-90 mm	49,40	A
1412520	ME RVS Ø 300 mm condensdop 3/4"	93,70	A
1412530	ME RVS Ø 300 mm condensafvoer Horizontaal	94,90	A
1412540	ME RVS Ø 300 mm klemband	10,70	A
1412570	ME RVS Ø 300 mm T-stuk 90° spuit Ø 100mm	175,30	A
1412497	ME RVS vergroftend verloop Ø 300 mm (< Ø opgeven)	97,00	A

ME RVS
 Ø 350 mm



1412900	ME RVS Ø 350 mm pijp L = 1000 mm	140,30	A
1412910	ME RVS Ø 350 mm pijp L = 500 mm	103,60	A
1412920	ME RVS Ø 350 mm pijp L = 250 mm	77,40	A
1412426	ME RVS Ø 350 mm pijp L = 150 mm	75,50	A
1412930	ME RVS Ø 350 mm bocht 87°	152,60	A
1412940	ME RVS Ø 350 mm bocht 45°	98,30	A
1412950	ME RVS Ø 350 mm bocht 30°	98,30	A
1412945	ME RVS Ø 350 mm bocht 15°	98,30	A
1412960	ME RVS Ø 350 mm paspijp 200 - 300 mm	115,90	A
1412972	ME RVS Ø 350 mm T-stuk 87°	207,00	A
1412970	ME RVS Ø 350 mm T-stuk 90°	207,00	A
1412955	ME RVS Ø 350 mm T-stuk 45°	325,80	A
1412965	ME RVS Ø 350 mm dop voor T-stuk	115,90	A
1412975	ME RVS Ø 350 mm trekkende kap	303,50	A
1412976	ME RVS Ø 350 mm trekkende kap met topgaas	367,80	A
1412990	ME RVS Ø 350 mm muurbeugel 25-90 mm	56,30	A
1412967	ME RVS Ø 350 mm condensdop 3/4"	103,90	A
1412966	ME RVS Ø 350 mm condensafvoer Horizontaal	102,20	A
1412985	ME RVS Ø 350 mm klemband	11,00	A
1412995	ME RVS Ø 350 mm T-stuk 90° spuit Ø 100mm	231,50	A



ROOKGASKANALEN

Enkelwandig RVS blank Kachel/Open Haardkanaal Rite Vent - Schiedel

ME RVS
Ø 400 mm



Artikelnr.	Omschrijving	Brutoprijs	Krt.G
1412700	ME RVS Ø 400 mm pijp L = 1000 mm	161,30	A
1412710	ME RVS Ø 400 mm pijp L = 500 mm	112,20	A
1412720	ME RVS Ø 400 mm pijp L = 250 mm	86,00	A
1412725	ME RVS Ø 400 mm pijp L = 150 mm	83,50	A
1412740	ME RVS Ø 400 mm bocht 87°	177,00	A
1412735	ME RVS Ø 400 mm bocht 45°	112,60	A
1412745	ME RVS Ø 400 mm bocht 30°	112,60	A
1412747	ME RVS Ø 400 mm bocht 15°	112,60	A
1412730	ME RVS Ø 400 mm paspijp 200 - 300 mm	133,20	A
1412760	ME RVS Ø 400 mm T-stuk 87°	245,40	A
1412750	ME RVS Ø 400 mm T-stuk 90°	245,40	A
1412765	ME RVS Ø 400 mm T-stuk 45°	368,10	A
1412755	ME RVS Ø 400 mm dop voor T-stuk	124,60	A
1412840	ME RVS Ø 400 mm trekkende kap	362,70	A
1412843	ME RVS Ø 400 mm trekkende kap met topgaas	422,00	A
1412800	ME RVS Ø 400 mm muurbeugel 25-90 mm	70,20	A
1412780	ME RVS Ø 400 mm condensdop 3/4"	119,20	A
1412870	ME RVS Ø 400 mm condensafvoer Horizontaal	115,80	A
1412790	ME RVS Ø 400 mm klemband	12,30	A

ME RVS
Ø 450 mm



1413000	ME RVS Ø 450 mm pijp L = 1000 mm	241,80	A
1413010	ME RVS Ø 450 mm pijp L = 500 mm	168,20	A
1413020	ME RVS Ø 450 mm pijp L = 250 mm	128,90	A
1413022	ME RVS Ø 450 mm pijp L = 150 mm	126,20	A
1413030	ME RVS Ø 450 mm bocht 87°	265,50	A
1413102	ME RVS Ø 450 mm bocht 45°	168,20	A
1413100	ME RVS Ø 450 mm bocht 30°	168,20	A
1413104	ME RVS Ø 450 mm bocht 15°	168,20	A
1413050	ME RVS Ø 450 mm paspijp 200 - 300 mm	199,90	A
1413110	ME RVS Ø 450 mm T-stuk 87°	368,00	A
1413120	ME RVS Ø 450 mm T-stuk 90°	368,00	A
1413130	ME RVS Ø 450 mm T-stuk 45°	551,80	A
1413090	ME RVS Ø 450 mm dop voor T-stuk	186,80	A
1413080	ME RVS Ø 450 mm trekkende kap	544,10	A
1413140	ME RVS Ø 450 mm muurbeugel 25-90 mm	115,80	A
1413040	ME RVS Ø 450 mm condensdop 3/4"	178,90	A
1413160	ME RVS Ø 450 mm condensafvoer Horizontaal	173,60	A
1413095	ME RVS Ø 450 mm klemband	18,60	A

* ME in de diameters 500 mm t/m 1100 mm op aanvraag



HOOFDSTUK 4

Rookgaskanalen RVS Concentrisch

Omschrijving	Pagina
Concentrisch RVS blank voor gashaarden CFS Ø 80/130 mm - Ø 100/150 mm	58
Concentrisch RVS blank voor gashaarden CFS Ø 130/200 mm	59
Systeemoverzicht Schiedel CFS concentrisch blank	60
Concentrisch RVS blank US voor pelletkachels Ø 100/150 mm	61
Concentrisch RVS blank US voor pelletkachels Ø 130/200 mm	62



ROOKGASKANALEN

Concentrisch RVS voor gashaarden Schiedel CFS

Concentrisch
 Ø 80/130 mm
 RVS - CFS



Artikelnr.	Omschrijving	Brutoprijs	Krt.G
1420010	Conc. CFS RVS/RVS 80/130 mm pijp L = 1000 mm	72,00	A
1420020	Conc. CFS RVS/RVS 80/130 mm pijp L = 500 mm	50,70	A
1420030	Conc. CFS RVS/RVS 80/130 mm pijp L = 250 mm	38,70	A
1420040	Conc. CFS RVS/RVS 80/130 mm paspijp 375-585 mm	104,80	A
1420050	Conc. CFS RVS/RVS 80/130 mm bocht 15°	64,80	A
1420060	Conc. CFS RVS/RVS 80/130 mm bocht 30°	65,50	A
1420070	Conc. CFS RVS/RVS 80/130 mm bocht 45°	66,50	A
1420080	Conc. CFS RVS/RVS 80/130 mm bocht 90°	73,50	A
1420090	Conc. CFS RVS/RVS 80/130 mm bocht 90° + inspectieluik	206,70	A
1420100	Conc. CFS RVS/RVS 80/130 mm dakdoorvoer	151,10	A
1102500	Conc. CFS RVS/RVS 80/130 mm loodslab 20° - 45°	199,40	A
1102600	Conc. CFS RVS/RVS 80/130 mm loodslab 45° - 60°	215,00	A
1420130	Conc. CFS RVS/RVS 80/130 mm dakplaat platdak	84,90	A
1420140	Conc. CFS RVS/RVS 80/130 mm geveldoorvoer	105,90	A
1420150	Conc. CFS RVS/RVS 80/130 mm muurdoorvoer	86,50	A
1101200	Conc. CFS RVS/RVS 80/130 mm stormkraag	32,20	A
1102700	Conc. CFS RVS/RVS 80/130 mm tuidraadbeugel	20,70	A
1420180	Conc. CFS RVS/RVS 80/130 mm T-stuk 90°	107,70	A
1420190	Conc. CFS RVS/RVS 80/130 mm Inspectie T-stuk	151,40	A
1420200	Conc. CFS RVS/RVS 80/130 mm condensdop	58,40	A
1102100	Conc. CFS RVS/RVS 80/130 mm muurbeugel vast	36,30	A
1420220	Conc. CFS RVS/RVS 80/130 mm verlengset beugel	24,50	A
1420230	Conc. CFS RVS/RVS 80/130 mm rozet	34,80	A

Concentrisch
 Ø 100/150 mm
 RVS - CFS



1420300	Conc. CFS RVS/RVS 100/150 mm pijp L = 1000 mm	86,90	A
1420310	Conc. CFS RVS/RVS 100/150 mm pijp L = 500 mm	60,10	A
1420320	Conc. CFS RVS/RVS 100/150 mm pijp L = 250 mm	45,00	A
1420330	Conc. CFS RVS/RVS 100/150 mm paspijp 375-585 mm	114,70	A
1420340	Conc. CFS RVS/RVS 100/150 mm bocht 15°	73,80	A
1420350	Conc. CFS RVS/RVS 100/150 mm bocht 30°	76,20	A
1420360	Conc. CFS RVS/RVS 100/150 mm bocht 45°	77,20	A
1420370	Conc. CFS RVS/RVS 100/150 mm bocht 90°	84,20	A
1420380	Conc. CFS RVS/RVS 100/150 mm bocht 90° + inspectieluik	239,30	A
1420390	Conc. CFS RVS/RVS 100/150 mm dakdoorvoer	173,90	A
1102510	Conc. CFS RVS/RVS 100/150 mm loodslab 20° - 45°	199,40	A
1102610	Conc. CFS RVS/RVS 100/150 mm loodslab 45° - 60°	215,00	A
1102210	Conc. CFS RVS/RVS 100/150 mm dakplaat platdak	74,10	A
1420430	Conc. CFS RVS/RVS 100/150 mm geveldoorvoer	123,90	A
1420440	Conc. CFS RVS/RVS 100/150 mm muurdoorvoer	99,90	A
1101210	Conc. CFS RVS/RVS 100/150 mm stormkraag	34,50	A
1102710	Conc. CFS RVS/RVS 100/150 mm tuidraadbeugel	22,70	A
1420470	Conc. CFS RVS/RVS 100/150 mm T-stuk 90°	122,20	A
1420480	Conc. CFS RVS/RVS 100/150 mm Inspectie T-stuk	176,60	A
1420490	Conc. CFS RVS/RVS 100/150 mm condensdop	75,10	A
1102110	Conc. CFS RVS/RVS 100/150 mm muurbeugel	36,30	A
1420220	Conc. CFS RVS/RVS 100/150 mm verlengset beugel	24,50	A
1420510	Conc. CFS RVS/RVS 100/150 mm rozet	35,40	A

* Standaard geleverd met klembeugel



ROOKGASKANALEN

Concentrisch RVS voor gashaarden Schiedel CFS

Concentrisch
 Ø 130/200 mm
 RVS - CFS



Artikelnr.	Omschrijving	Brutoprijs	Krt.G
1420600	Conc. CFS RVS/RVS 130/200 mm pijp L = 1000 mm	112,80	A
1420610	Conc. CFS RVS/RVS 130/200 mm pijp L = 500 mm	77,00	A
1420620	Conc. CFS RVS/RVS 130/200 mm pijp L = 250 mm	55,10	A
1420630	Conc. CFS RVS/RVS 130/200 mm paspijp 375-585 mm	129,80	A
1420640	Conc. CFS RVS/RVS 130/200 mm bocht 15°	85,90	A
1420650	Conc. CFS RVS/RVS 130/200 mm bocht 30°	88,90	A
1420660	Conc. CFS RVS/RVS 130/200 mm bocht 45°	90,20	A
1420670	Conc. CFS RVS/RVS 130/200 mm bocht 90°	107,50	A
1420680	Conc. CFS RVS/RVS 130/200 mm bocht 90° + inspectieluik	262,20	A
1420690	Conc. CFS RVS/RVS 130/200 mm dakdoorvoer	192,40	A
1102530	Conc. CFS RVS/RVS 130/200 mm loodslab 20° - 45°	201,90	A
1102630	Conc. CFS RVS/RVS 130/200 mm loodslab 45° - 60°	230,30	A
1102230	Conc. CFS RVS/RVS 130/200 mm dakplaat platdak	74,10	A
1420730	Conc. CFS RVS/RVS 130/200 mm geveldoorvoer	153,10	A
1420740	Conc. CFS RVS/RVS 130/200 mm muurdoorvoer	123,30	A
1101230	Conc. CFS RVS/RVS 130/200 mm stormkraag	41,10	A
1102730	Conc. CFS RVS/RVS 130/200 mm tuidraadbeugel	24,70	A
1420770	Conc. CFS RVS/RVS 130/200 mm T-stuk 90°	157,80	A
1420780	Conc. CFS RVS/RVS 130/200 mm Inspectie T-stuk	207,00	A
1420790	Conc. CFS RVS/RVS 130/200 mm condensdop	80,40	A
1102130	Conc. CFS RVS/RVS 130/200 mm muurbeugel vast	37,80	A
1420810	Conc. CFS RVS/RVS 130/200 mm verlengset beugel	24,50	A
1420820	Conc. CFS RVS/RVS 130/200 mm rozet	38,70	A

* Standaard geleverd met klembeugel



Schiedel CFS

Stysteemoverzicht

Productomschrijving	CFS is een modulair, concentrisch rookgasafvoersysteem van hoogwaardig roestvrij staal voor gebalanceerde rookgasafvoertoepassingen. Het systeem is ontworpen voor al dan niet condenserende gas- of olietoestellen met gesloten verbrandingsruimte in over- of onderdruk met een continue bedrijfstemperatuur tot maximaal 200 °C.
Installatie	Buiten of in een gebouw
Brandstoffen	Gas en olie
Bedrijfstemperatuur	≤ 200 °C
Werkingswijze	- Onderdruk (N1 ≤ 40 Pa) - Overdruk (P1 ≤ 200 Pa) met keerringdichtingen van silicone - Nat/Droog
Materiaal binnenbuis	EN 1.4404 (AISI 316L), 0,4 mm dik
Materiaal buitenbuis	EN 1.4301 (AISI 304), 0,4 mm dik
Afwerking buitenbuis	- BA (blankgeglieid) - RAL-kleur optioneel
Verbinding	Push-fit systeem, onderdelen bevestigd met klemband
Diameters	80/130, 100/150, 130/200
CE-certificeringsnummer EN 1856-1:	CE-aanduiding EN 1856-1:
0036 – CPR – 91236-045	T200 P1 W V2 L50040 O00 T200 N1 D Vm L20040 O00 T600 N1 W V2 L50040 O50 T600 N1 D Vm L20040 O50

Stysteemkenmerken:

- multifunctioneel concentrisch systeem in licht ontwerp
- geschikt voor binnen- en buitentoepassingen
- siliconedichtingen verzekeren P1-drukbestendigheid
- met Viton-dichtingen bij toepassing van olietoestellen
- hoogwaardige technische verbindingen bevestigd met klembanden
- breed scala van eenvoudig te installeren accessoires
- kan worden gecombineerd met Schiedel Prima Plus- en ICS-systeem

Toepassingsgebied:

- rookgasafvoer en luchttoevoer van toestellen met gesloten verbrandingsruimte
- condensatietoestellen
- voor particulier of commercieel gebruik



ROOKGASKANALEN

Concentrisch RVS US voor gashaarden

Concentrisch
RVS - US
Ø 100/150 mm



Artikelnr.	Omschrijving	Brutoprijs	Krt.G
1400010	Conc. US RVS/RVS Ø 100/150 mm pijp L = 1000 mm	99,20	A
1400020	Conc. US RVS/RVS Ø 100/150 mm pijp L = 500 mm	75,60	A
1400030	Conc. US RVS/RVS Ø 100/150 mm pijp L = 250 mm	64,00	A
1400040	Conc. US RVS/RVS Ø 100/150 mm paspijp L = 60 - 250 mm	94,30	A
1400050	Cons. US RVS/RVS Ø 100/150 mm bocht 15°	99,20	A
1400060	Cons. US RVS/RVS Ø 100/150 mm bocht 30°	99,20	A
1400070	Cons. US RVS/RVS Ø 100/150 mm bocht 45°	99,20	A
1400080	Cons. US RVS/RVS Ø 100/150 mm bocht 90°	124,60	A
1400090	Cons. US RVS/RVS Ø 100/150 mm aansluitstuk laag	32,00	A
1400100	Cons. US RVS/RVS Ø 100/150 mm aansluitstuk 80/150	38,80	A
1400110	Cons. US RVS/RVS Ø 100/150 mm set centreerplaten	38,70	A
1400120	Cons. US RVS/RVS Ø 100/150 mm dakdoorvoer	223,60	A
1400130	Cons. US RVS/RVS Ø 100/150 mm geveldoorvoer	127,80	A
1400140	Cons. US RVS/RVS Ø 100/150 mm dakplaat hellend dak 5°-30°	75,60	A
1400150	Cons. US RVS/RVS Ø 100/150 mm dakplaat platdak Alu	45,40	A
1400160	Cons. US RVS/RVS Ø 100/150 mm dakplaat platdak RVS	75,60	A
1400170	Cons. US RVS/RVS Ø 100/150 mm loodslab 20°-45°	127,80	A
1400180	Cons. US RVS/RVS Ø 100/150 mm loodslab 45°-60°	185,00	A
1400190	Cons. US RVS/RVS Ø 100/150 mm dakbevest.beugel zwaar	50,50	A
1400200	Cons. US RVS/RVS Ø 100/150 mm montagebeugel	15,20	A
1400210	Cons. US RVS/RVS Ø 100/150 mm klemband	10,10	A
1400220	Cons. US RVS/RVS Ø 100/150 mm muurbeugel	37,10	A
1400230	Cons. US RVS/RVS Ø 100/150 mm stormkraag	22,00	A
1400240	Cons. US RVS/RVS Ø 100/150 mm muur/montageplaat	32,10	A
1400250	Cons. US RVS/RVS Ø 100/150 mm bovenkant saneringsset	102,60	A
1400260	Cons. US RVS/RVS Ø 100/150 mm onderkant saneringsset	102,60	A
1400270	Cons. US RVS/RVS Ø 100/150 mm verkleiner 130>100	94,30	A
1400280	Cons. US RVS/RVS Ø 100/150 mm adaptor	33,40	A

* Standaard geleverd zonder klemband



ROOKGASKANALEN

Concentrisch RVS US voor gashaarden

Concentrisch
RVS - US
Ø 130/200 mm



Artikelnr.	Omschrijving	Brutoprijs	Krt.G
1400300	Conc. US RVS/RVS Ø 130/200 mm pijp L = 1000 mm	122,80	A
1400310	Conc. US RVS/RVS Ø 130/200 mm pijp L = 500 mm	109,40	A
1400320	Conc. US RVS/RVS Ø 130/200 mm pijp L = 250 mm	82,40	A
1400330	Conc. US RVS/RVS Ø 130/200 mm paspijp L = 60 - 250 mm	109,40	A
1400340	Cons. US RVS/RVS Ø 130/200 mm bocht 15°	132,90	A
1400350	Cons. US RVS/RVS Ø 130/200 mm bocht 30°	132,90	A
1400360	Cons. US RVS/RVS Ø 130/200 mm bocht 45°	132,90	A
1400370	Cons. US RVS/RVS Ø 130/200 mm bocht 90°	168,20	A
1400380	Cons. US RVS/RVS Ø 130/200 mm aansluitstuk laag	38,90	A
1400390	Cons. US RVS/RVS Ø 130/200 mm set centreerplaten	37,10	A
1400400	Cons. US RVS/RVS Ø 130/200 mm dakdoorvoer	327,80	A
1400410	Cons. US RVS/RVS Ø 130/200 mm geveldoorvoer	262,30	A
1400420	Cons. US RVS/RVS Ø 130/200 mm dakplaat hellend dak 5°-30°	87,50	A
1400430	Cons. US RVS/RVS Ø 130/200 mm dakplaat platdak Alu	59,00	A
1400440	Cons. US RVS/RVS Ø 130/200 mm dakplaat platdak RVS	87,80	A
1400450	Cons. US RVS/RVS Ø 130/200 mm loodslab 20°-45°	154,70	A
1400460	Cons. US RVS/RVS Ø 130/200 mm loodslab 45°-60°	198,40	A
1400470	Cons. US RVS/RVS Ø 130/200 mm dakbevest.beugel zwaar	55,50	A
1400480	Cons. US RVS/RVS Ø 130/200 mm montagebeugel	16,90	A
1400490	Cons. US RVS/RVS Ø 130/200 mm klemband	16,90	A
1400500	Cons. US RVS/RVS Ø 130/200 mm muurbeugel	42,10	A
1400510	Cons. US RVS/RVS Ø 130/200 mm stormkraag	28,80	A
1400520	Cons. US RVS/RVS Ø 130/200 mm muur/montageplaat	43,90	A
1400530	Cons. US RVS/RVS Ø 130/200 mm vergroter 100>130	94,30	A
1400540	Cons. US RVS/RVS Ø 130/200 mm adaptor Dru	40,80	A

* Standaard geleverd zonder klemband



HOOFDSTUK 5

Rookgaskanalen RVS Flexibel

Omschrijving	Pagina
RVS Flexibel voor kachel/O.H./CV Ø 60 mm-Ø 80 mm-Ø 100 mm	64
RVS Flexibel voor kachel/O.H./CV Ø 110 mm - Ø 125 mm - Ø 130 mm	65
RVS Flexibel voor kachel/O.H./CV Ø 150 mm - Ø 180 mm	66
RVS Flexibel voor kachel/O.H./CV Ø 200 mm - Ø 225 mm - Ø 250 mm - Ø 300 mm	67

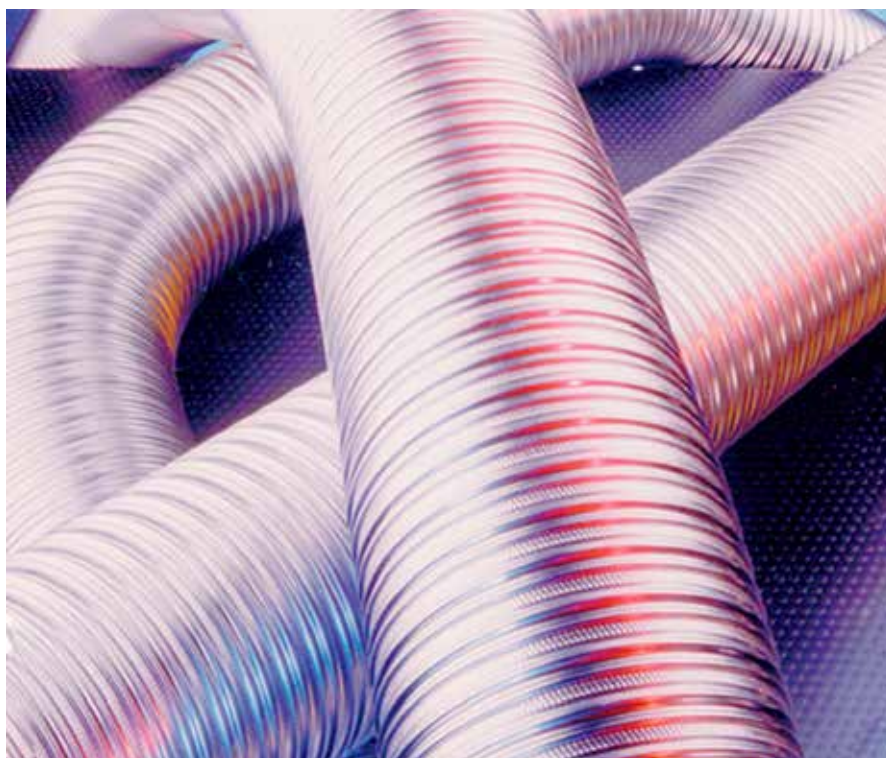

ROOKGASKANALEN

RVS Flexibel voor Kachel / Open Haard / CV

RVS Flex
 Ø 60 mm



Artikelnr.	Omschrijving	Brutoprijs	Krt.G
1300015	Flex RVS 316 enkel gelaagd Ø 60 mm per meter	22,30	A
1300010	Flex RVS 316 dubbel gelaagd Ø 60 mm per meter	34,80	A
1300620	Flex RVS QA verloop Ø 60 mm - Ø 80 mm met ring	49,50	A
1300600	Flex RVS QA regenkap Ø 60 mm	76,20	A
1300610	Flex RVS QA afdekplaat Ø 60 mm	42,80	A
1300205	Flex RVS aansluitstuk Ø 60 mm zonder ring	34,50	A

RVS Flex
 Ø 80 mm



1300030	Flex RVS 316 QA enkel gelaagd Ø 80 mm per meter	21,30	A
1300040	Flex RVS 316 dubbel gelaagd Ø 80 mm per meter	38,40	A
1300170	Flex RVS QA aansluitstuk met Ring Ø 80 mm	38,70	A
1300200	Flex RVS aansluitstuk zonder ring Ø 80 mm	16,50	A
1300400	Flex RVS regenkap met stormkraag QA Ø 80mm	98,80	A
1411150	Flex RVS stormkraag Ø 80 mm	12,40	A
1300324	Flex RVS schoorsteenafdekplaat B/O Ø 80mm	45,30	A
1300440	Flex RVS Pan regenkap Ø 80 mm	78,50	A
1300450	Flex RVS Pan afdekplaat Ø 80 mm	71,20	A
1221800	Flex RVS trekkende kap Ø 80 mm	58,80	A
1300353	Flex RVS trekkende kap met veegluik Ø 80 mm	99,40	A
1300615	Flex RVS Wormslangklem zwaar Ø 80 mm	5,10	A
1300800	Flex RVS topadapter draai Ø 80 mm (Dubbel Gelaagd)	23,40	A
1300805	Flex RVS onderadapter draai Ø 80 mm (Dubbel Gelaagd)	23,80	A
1300900	Flex RVS koppelstuk draai Ø 80 mm (Dubbel Gelaagd)	31,00	A
1300902	Flex RVS trekconus draai Ø 80 mm (Dubbel Gelaagd)	33,80	A

RVS Flex
 Ø 100 mm



1300050	Flex RVS 316 QA enkel gelaagd Ø 100 mm per meter	25,20	A
1300055	Flex RVS 316 dubbel gelaagd Ø 100 mm per meter	41,20	A
1300180	Flex RVS QA aansluitstuk met Ring Ø 100 mm	43,70	A
1300210	Flex RVS aansluitstuk zonder ring Ø 100 mm	18,60	A
1300410	Flex RVS regenkap met stormkraag QA Ø 100mm	108,50	A
1411350	Flex RVS stormkraag Ø 100 mm	14,20	A
1300325	Flex RVS schoorsteenafdekplaat B/O Ø 100mm	46,50	A
1300442	Flex RVS Pan regenkap Ø 100 mm	98,00	A
1300452	Flex RVS Pan afdekplaat Ø 100 mm	91,70	A
1221810	Flex RVS trekkende kap Ø 100 mm	61,50	A
1300352	Flex RVS trekkende kap met veegluik Ø 100 mm	101,70	A
1221850	Flex RVS trekkende kap met vonkengaas Ø 100 mm	97,10	A
1300810	Flex RVS topadapter draai Ø 100 mm (Dubbel Gelaagd)	24,30	A
1300811	Flex RVS topadapter draai Ø 100 mm (Enkel Gelaagd)	27,70	A
1300815	Flex RVS onderadapter draai Ø 100 mm (Dubbel Gelaagd)	24,70	A
1300816	Flex RVS onderadapter draai Ø 100 mm (Enkel Gelaagd)	33,70	A
1300910	Flex RVS koppelstuk draai Ø 100 mm (Dubbel Gelaagd)	35,80	A
1300911	Flex RVS koppelstuk draai Ø 100 mm (Enkel Gelaagd)	39,40	A
1300912	Flex RVS trekconus draai Ø 100 mm (Dubbel Gelaagd)	33,80	A
1300913	Flex RVS trekconus draai Ø 100 mm (Enkel Gelaagd)	40,30	A

Flex Ø 80 mm en Ø 100 mm 65% korting bij een volle rol (30 meter)



ROOKGASKANALEN

RVS Flexibel voor Kachel / Open Haard / CV

RVS Flex
 Ø 110 mm



Artikelnr.	Omschrijving	Brutoprijs	Krt.G
1300060	Flex RVS 316 QA enkel gelaagd Ø 110 mm per meter	36,60	A
1300550	Flex RVS 316 dubbel gelaagd Ø 110 mm per meter	49,50	A
1300190	Flex RVS QA aansluitstuk met Ring Ø 110 mm	49,70	A
1300225	Flex RVS aansluitstuk zonder ring Ø 110 mm	21,70	A
1300415	Flex RVS regenkap met stormkraag QA Ø 110mm	113,70	A
1300425	Flex RVS stormkraag Ø 110 mm	43,80	A
1300331	Flex RVS schoorsteenafdekplaat B/O Ø 110 mm	50,00	A
1221813	Flex RVS trekkende kap Ø 110 mm	75,00	A
1300420	Flex RVS trekkende kap met veegluik Ø 110 mm	127,70	A

RVS Flex
 Ø 125 mm



1300070	Flex RVS 316 QA enkel gelaagd Ø 125 mm per meter	39,90	A
1300500	Flex RVS 316 dubbel gelaagd Ø 125 mm per meter	52,30	A
1300220	Flex RVS aansluitstuk zonder ring Ø 125 mm	21,70	A
1300475	Flex RVS stormkraag Ø 125 mm	47,90	A
1300363	Flex RVS schoorsteenafdekplaat B/O Ø 125 mm	50,50	A
1300075	Flex RVS nisbusaansluiting Ø 125 mm	63,90	A
1221815	Flex RVS trekkende kap Ø 125 mm	99,00	A
1300356	Flex RVS trekkende kap met veegluik Ø 125 mm	123,60	A
1221825	Flex RVS trekkende kap met vonkengaas Ø 125 mm	127,70	A
1300915	Flex RVS koppelstuk draai Ø 125 mm (Dubbel Gelaagd)	37,90	A
1300916	Flex RVS koppelstuk draai Ø 125 mm (Enkel Gelaagd)	40,00	A
1300917	Flex RVS trekconus draai Ø 125 mm (Dubbel Gelaagd)	33,20	A
1300918	Flex RVS trekconus draai Ø 125 mm (Enkel Gelaagd)	39,80	A

RVS Flex
 Ø 130 mm



1300080	Flex RVS 316 QA enkel gelaagd Ø 130 mm per meter	41,20	A
1300580	Flex RVS 316 dubbel gelaagd Ø 130 mm per meter	60,00	A
1300235	Flex RVS aansluitstuk zonder ring Ø 130 mm	24,80	A
1101200	Flex RVS stormkraag Ø 130 mm	32,20	A
1300364	Flex RVS schoorsteenafdekplaat B/O Ø 130 mm	52,60	A
1300085	Flex RVS nisbusaansluiting Ø 130 mm	66,00	A
1221820	Flex RVS trekkende kap Ø 130 mm	65,80	A
1300357	Flex RVS trekkende kap met veegluik Ø 130 mm	111,30	A
1221860	Flex RVS trekkende kap met vonkengaas Ø 130 mm	101,50	A
1300820	Flex RVS topadapter draai Ø 130 mm (Dubbel Gelaagd)	26,00	A
1300821	Flex RVS topadapter draai Ø 130 mm (Enkel Gelaagd)	29,50	A
1300825	Flex RVS onderadapter draai Ø 130 mm (Dubbel Gelaagd)	26,30	A
1300826	Flex RVS onderadapter draai Ø 130 mm (Enkel Gelaagd)	35,50	A
1300920	Flex RVS koppelstuk draai Ø 130 mm (Dubbel Gelaagd)	37,50	A
1300921	Flex RVS koppelstuk draai Ø 130 mm (Enkel Gelaagd)	43,50	A
1300922	Flex RVS trekconus draai Ø 130 mm (Dubbel Gelaagd)	34,70	A
1300923	Flex RVS trekconus draai Ø 130 mm (Enkel Gelaagd)	41,40	A

Flex Ø 125 mm en Ø 130 mm 65% korting bij een volle rol (30 meter)



ROOKGASKANALEN

RVS Flexibel voor Kachel / Open Haard / CV

RVS Flex
 Ø 150 mm



Artikelnr.	Omschrijving	Brutoprijs	Krt.G
1300090	Flex RVS 316 enkel gelaagd Ø 150 mm per meter	37,80	A
1300510	Flex RVS 316 dubbel gelaagd Ø 150 mm per meter	62,60	A
1300230	Flex RVS aansluitstuk zonder ring Ø 150 mm	25,30	A
1101210	Flex RVS stormkraag Ø 150 mm	34,50	A
1300365	Flex RVS schoorsteenafdekplaat B/O Ø 150 mm	55,60	A
1300095	Flex RVS nisbusaansluiting Ø 150 mm	69,50	A
1221830	Flex RVS trekkende kap Ø 150 mm	72,00	A
1300355	Flex RVS trekkende kap met veegluik Ø 150 mm	121,30	A
1221840	Flex RVS trekkende kap met vonkengaas Ø 150 mm	108,10	A
1300830	Flex RVS topadapter draai Ø 150 mm (Dubbel Gelaagd)	29,10	A
1300831	Flex RVS topadapter draai Ø 150 mm (Enkel Gelaagd)	34,20	A
1300835	Flex RVS onderadapter draai Ø 150 mm (Dubbel Gelaagd)	29,50	A
1300836	Flex RVS onderadapter draai Ø 150 mm (Enkel Gelaagd)	40,20	A
1300930	Flex RVS koppelstuk draai Ø 150 mm (Dubbel Gelaagd)	42,20	A
1300931	Flex RVS koppelstuk draai Ø 150 mm (Enkel Gelaagd)	46,80	A
1300932	Flex RVS trekconus draai Ø 150 mm (Dubbel Gelaagd)	34,90	A
1300933	Flex RVS trekconus draai Ø 150 mm (Enkel Gelaagd)	42,00	A

RVS Flex
 Ø 180 mm



1300100	Flex RVS 316 enkel gelaagd Ø 180 mm per meter	56,50	A
1300520	Flex RVS 316 dubbel gelaagd Ø 180 mm per meter	75,00	A
1300240	Flex RVS aansluitstuk zonder ring Ø 180 mm	27,80	A
1101220	Flex RVS stormkraag Ø 180 mm	37,60	A
1300366	Flex RVS schoorsteenafdekplaat B/O Ø 180 mm	67,50	A
1300103	Flex RVS nisbusaansluiting Ø 180 mm	73,70	A
1221831	Flex RVS trekkende kap Ø 180 mm	81,10	A
1300358	Flex RVS trekkende kap met veegluik Ø 180 mm	127,90	A
1221845	Flex RVS trekkende kap met vonkengaas Ø 180 mm	120,30	A
1300840	Flex RVS topadapter draai Ø 180 mm (Dubbel Gelaagd)	30,80	A
1300841	Flex RVS topadapter draai Ø 180 mm (Enkel Gelaagd)	36,90	A
1300845	Flex RVS onderadapter draai Ø 180 mm (Dubbel Gelaagd)	31,60	A
1300846	Flex RVS onderadapter draai Ø 180 mm (Enkel Gelaagd)	43,30	A
1300940	Flex RVS koppelstuk draai Ø 180 mm (Dubbel Gelaagd)	47,80	A
1300941	Flex RVS koppelstuk draai Ø 180 mm (Enkel Gelaagd)	50,10	A
1300942	Flex RVS trekconus draai Ø 180 mm (Dubbel Gelaagd)	35,00	A
1300943	Flex RVS trekconus draai Ø 180 mm (Enkel Gelaagd)	43,00	A

Flex Ø 150 mm 65% korting bij een volle rol (30 meter)



ROOKGASKANALEN

RVS Flexibel voor Kachel / Open Haard / CV

RVS Flex
 Ø 200 mm



Artikelnr.	Omschrijving	Brutoprijs	Krt.G
1300110	Flex RVS 316 enkel gelaagd Ø 200 mm per meter	68,00	A
1300530	Flex RVS 316 dubbel gelaagd Ø 200 mm per meter	85,50	A
1300250	Flex RVS aansluitstuk zonder ring Ø 200 mm	29,90	A
1101230	Flex RVS stormkraag Ø 200 mm	41,10	A
1300367	Flex RVS schoorsteenafdekplaat B/O Ø 200 mm	69,60	A
1300113	Flex RVS nisbusaansluiting Ø 200 mm	77,90	A
1221832	Flex RVS trekkende kap Ø 200 mm	87,70	A
1300359	Flex RVS trekkende kap met veegluik Ø 200 mm	140,10	A
1221855	Flex RVS trekkende kap met vonkengaas Ø 200 mm	125,70	A
1300850	Flex RVS topadapter draai Ø 200 mm (Dubbel Gelaagd)	34,30	A
1300851	Flex RVS topadapter draai Ø 200 mm (Enkel Gelaagd)	39,90	A
1300855	Flex RVS onderadapter draai Ø 200 mm (Dubbel Gelaagd)	33,60	A
1300856	Flex RVS onderadapter draai Ø 200 mm (Enkel Gelaagd)	49,50	A
1300950	Flex RVS koppelstuk draai Ø 200 mm (Dubbel Gelaagd)	48,10	A
1300951	Flex RVS koppelstuk draai Ø 200 mm (Enkel Gelaagd)	53,60	A
1300952	Flex RVS trekconus draai Ø 200 mm (Dubbel Gelaagd)	35,30	A
1300953	Flex RVS trekconus draai Ø 200 mm (Enkel Gelaagd)	43,60	A

RVS Flex
 Ø 225 mm



1300120	Flex RVS 316 enkel gelaagd Ø 225 mm per meter	98,50	A
1300255	Flex RVS aansluitstuk zonder ring Ø 225 mm	50,00	A
1221960	Flex RVS stormkraag Ø 225 mm	42,80	A
1300369	Flex RVS schoorsteenafdekplaat B/O Ø 225 mm	125,30	A
1300354	Flex RVS trekkende kap met veegluik Ø 225 mm	244,30	A

RVS Flex
 Ø 250 mm



1300130	Flex RVS 316 enkel gelaagd Ø 250 mm per meter	106,60	A
1300540	Flex RVS 316 dubbel gelaagd Ø 250 mm per meter	135,90	A
1300260	Flex RVS aansluitstuk zonder ring Ø 250 mm	32,50	A
1101250	Flex RVS stormkraag Ø 250 mm	46,90	A
1300368	Flex RVS schoorsteenafdekplaat B/O Ø 250 mm	83,50	A
1300135	Flex RVS nisbusaansluiting Ø 250 mm	82,10	A
1221833	Flex RVS trekkende kap Ø 250 mm	122,60	A
1300351	Flex RVS trekkende kap met veegluik Ø 250 mm	169,80	A
1221865	Flex RVS trekkende kap met vonkengaas Ø 250 mm	150,00	A

RVS Flex
 Ø 300 mm



1300153	Flex RVS 316 enkel gelaagd Ø 300 mm per meter	113,30	A
1300155	Flex RVS 316 dubbel gelaagd Ø 300 mm per meter	144,20	A
1300270	Flex RVS aansluitstuk zonder ring Ø 300 mm	40,17	A
1101260	Flex RVS stormkraag Ø 300 mm	53,40	A
1300362	Flex RVS schoorsteenafdekplaat B/O Ø 300 mm	94,80	A
1300157	Flex RVS nisbusaansluiting Ø 300 mm	93,70	A
1221834	Flex RVS trekkende kap Ø 300 mm	146,30	A
1300372	Flex RVS trekkende kap met veegluik Ø 300 mm	189,70	A
1221870	Flex RVS trekkende kap met vonkengaas Ø 300 mm	172,00	A

HOOFDSTUK 6

Dakkappen / Uitmondingen

Omschrijving	Pagina
Draaiende kap-Gekken-Coltkappen-Kraaienkappen-Kruiskappen-Regenkap Geg.	71
Regenkap RVS-Tregakappen blank en zwart-Boldraadroosters-Combikap	72
RVS Trekkende kappen met veegluik en vonkengaas	73
Prefab Schoorstenen	74



B&E Installatie Groothandel

Prefab Schoorstenen

Custom Made



VENTURAHOLLAND

Uit liefde
voor het
stoken



- Van hoogwaardige materialen zoals RVS en aluminium
- Doordachte designs voorkomen inregenen
- Geschikt voor vrijwel alle diameters kanalen
- Geïmporteerd en gefabriceerd door VenturaHolland B.V.
- Trekbevorderende eigenschappen
- Optimale bescherming van uw rookkanaal
- Standaard 5 jaar garantie (m.u.v. Ventura Spinner)
- Verwerking van vonkengas voor rieten daken
- Eenvoudige online productregistratie



ROOKGASKANALEN

Dakkappen

Draaiende Kap



Artikelnr.	Omschrijving	Brutoprijs	Krt.G
1730090	Turbine Spinner RVS 80/250 blank met veegopening	251,00	A
1730100	Turbine Spinner RVS 80/250 zwart met veegopening	265,00	A
1730050	Turbine Spinner RVS 80/250 blank zonder veegopening	164,00	A
1730120	Turbine Junior Spinner RVS 80/180 zwart	241,00	A
1730130	Colt Rotorvent Turbolite RVS 80/250 blank	195,00	A
1730140	Colt Rotorvent Mini RVS 80/180 blank	182,50	A

RVS Gek



1730150	Draaikap RVS Gek instelbaar Ø 80 - 130 mm	231,20	A
1730160	Draaikap RVS Gek instelbaar Ø 130 - 160 mm	242,10	A
1730170	Draaikap RVS Gek instelbaar Ø 160 - 200 mm	251,30	A
1730180	Draaikap RVS Gek instelbaar Ø 200 - 240 mm	265,70	A

Coltkap



1730010	Coltkap Square zwart sendzimir	82,70	A
1730030	Coltkap Square blank RVS	183,00	A
1730040	Coltkap Square blank RVS Laag	168,20	A

Kraaienkop



1720300	Aluminium kraaienkop Ø 150 mm	22,80	A
1720340	Aluminium kraaienkop Ø 160 mm	26,10	A
1720310	Aluminium kraaienkop Ø 180 mm	26,30	A
1720320	Aluminium kraaienkop Ø 200 mm	30,50	A
1720330	Aluminium kraaienkop Ø 250 mm	66,90	A

Kruiskap



1720400	Aluminium kruiskap zwart Ø 130 mm	62,90	A
1720410	Aluminium kruiskap zwart Ø 150 mm	74,50	A
1720420	Aluminium kruiskap zwart Ø 180 mm	88,80	A
1720430	Aluminium kruiskap zwart Ø 200 mm	104,20	A
1720440	Aluminium kruiskap zwart Ø 250 mm	138,50	A

Regenkap Gegalvaniseerd



1710000	Regenkap gegalvaniseerd Ø 92 mm	15,00	A
1710005	Regenkap gegalvaniseerd Ø 100 mm	15,30	A
1710015	Regenkap gegalvaniseerd Ø 111 mm	15,30	A
1710020	Regenkap gegalvaniseerd Ø 121 mm	15,40	A
1710030	Regenkap gegalvaniseerd Ø 125 mm	16,10	A
1710035	Regenkap gegalvaniseerd Ø 131 mm	16,10	A
1710040	Regenkap gegalvaniseerd Ø 139 mm	16,60	A
1710050	Regenkap gegalvaniseerd Ø 150 mm	16,60	A
1710060	Regenkap gegalvaniseerd Ø 160 mm	16,90	A
1710070	Regenkap gegalvaniseerd Ø 170 mm	20,50	A
1710075	Regenkap gegalvaniseerd Ø 180 mm	20,50	A
1710080	Regenkap gegalvaniseerd Ø 200 mm	25,20	A
1710090	Regenkap gegalvaniseerd Ø 220 mm	36,10	A
1710100	Regenkap gegalvaniseerd Ø 250 mm	45,90	A
1710110	Regenkap gegalvaniseerd Ø 300 mm	72,00	A
1710120	Regenkap gegalvaniseerd Ø 350 mm	112,30	A
1710130	Regenkap gegalvaniseerd Ø 400 mm	130,40	A
1710140	Regenkap gegalvaniseerd Ø 450 mm	161,80	A
1710150	Regenkap gegalvaniseerd Ø 500 mm	197,80	A
1710160	Regenkap gegalvaniseerd Ø 550 mm	344,00	A
1710170	Regenkap gegalvaniseerd Ø 600 mm	381,10	A

ROOKGASKANALEN

Dakkappen

Regenkap RVS



Artikelnr.	Omschrijving	Brutoprijs	Krt.G
1760000	Regenkap RVS Ø 100 mm	43,20	A
1760010	Regenkap RVS Ø 111 mm	45,50	A
1760020	Regenkap RVS Ø 125 mm	45,50	A
1760025	Regenkap RVS Ø 131 mm	45,50	A
1760100	Regenkap RVS Ø 139 mm	45,80	A
1760030	Regenkap RVS Ø 150 mm	46,10	A
1760040	Regenkap RVS Ø 160 mm	48,00	A
1760050	Regenkap RVS Ø 180 mm	48,50	A
1760110	Regenkap RVS Ø 200 mm	57,00	A
1760060	Regenkap RVS Ø 250 mm	65,00	A
1760070	Regenkap RVS Ø 300 mm	118,00	A
1760080	Regenkap RVS Ø 350 mm	145,70	A
1760090	Regenkap RVS Ø 400 mm	167,50	A

Tregakap blank



1720010	Aluminium tregakap blank Ø 80 mm	41,50	A
1720020	Aluminium tregakap blank Ø 90 mm	42,20	A
1720030	Aluminium tregakap blank Ø 100 mm	43,20	A
1720040	Aluminium tregakap blank Ø 110 mm	48,00	A
1720060	Aluminium tregakap blank Ø 130 mm	57,80	A
1720070	Aluminium tregakap blank Ø 150 mm	78,80	A
1720080	Aluminium tregakap blank Ø 180 mm	110,50	A
1720090	Aluminium tregakap blank Ø 200 mm	123,60	A
1720085	Aluminium tregakap blank Ø 250 mm	302,40	A

Tregakap zwart



1720160	Aluminium tregakap zwart Ø 80 mm	50,60	A
1720170	Aluminium tregakap zwart Ø 90 mm	52,10	A
1720180	Aluminium tregakap zwart Ø 100 mm	53,80	A
1720190	Aluminium tregakap zwart Ø 110 mm	55,50	A
1720210	Aluminium tregakap zwart Ø 130 mm	64,90	A
1720220	Aluminium tregakap zwart Ø 150 mm	84,60	A
1720230	Aluminium tregakap zwart Ø 180 mm	117,80	A
1720240	Aluminium tregakap zwart Ø 200 mm	128,00	A

Boldraadrooster Gegalvaniseerd

1720510	Boldraadrooster Geg. Ø 80 - 100 mm	7,00	A
1720520	Boldraadrooster Geg. Ø 110 - 130 mm	7,30	A
1720530	Boldraadrooster Geg. Ø 140 - 160 mm	10,60	A
1720550	Boldraadrooster Geg. Ø 200 mm	24,60	A

Combikap

1730070	Schoorsteenkap Combi regenkap en boldraad zwart	48,40	A
---------	---	-------	---



ROOKGASKANALEN

Dakkappen

RVS Trekkap



Artikelnr.	Omschrijving	Brutoprijs	Krt.G
1221800	RVS Ø 80 mm trekkende kap	58,80	A
1221810	RVS Ø 100 mm trekkende kap	61,50	A
1221813	RVS Ø 110 mm trekkende kap	75,00	A
1221815	RVS Ø 125 mm trekkende kap	99,00	A
1221820	RVS Ø 130 mm trekkende kap	65,80	A
1221830	RVS Ø 150 mm trekkende kap	72,00	A
1221831	RVS Ø 180 mm trekkende kap	81,10	A
1221832	RVS Ø 200 mm trekkende kap	87,70	A
1221833	RVS Ø 250 mm trekkende kap	122,60	A
1221834	RVS Ø 300 mm trekkende kap	146,30	A
1221835	RVS Ø 350 mm trekkende kap	167,70	A

RVS Trekkap

Vonkengas



1221850	RVS Ø 100 mm trekkende kap met vonkengas	97,10	A
1221825	RVS Ø 125 mm trekkende kap met vonkengas	127,70	A
1221860	RVS Ø 130 mm trekkende kap met vonkengas	101,50	A
1221840	RVS Ø 150 mm trekkende kap met vonkengas	108,10	A
1221845	RVS Ø 180 mm trekkende kap met vonkengas	120,30	A
1221855	RVS Ø 200 mm trekkende kap met vonkengas	125,70	A
1221865	RVS Ø 250 mm trekkende kap met vonkengas	150,00	A
1221870	RVS Ø 300 mm trekkende kap met vonkengas	172,00	A
1221880	RVS Ø 350 mm trekkende kap met vonkengas	191,90	A

RVS Trekkap

Veegluik



1300353	RVS Ø 80 mm trekkende kap met veegluik	99,40	A
1300352	RVS Ø 100 mm trekkende kap met veegluik	101,70	A
1300420	RVS Ø 110 mm trekkende kap met veegluik	127,70	A
1300356	RVS Ø 125 mm trekkende kap met veegluik	123,60	A
1300357	RVS Ø 130 mm trekkende kap met veegluik	111,30	A
1300355	RVS Ø 150 mm trekkende kap met veegluik	121,30	A
1300358	RVS Ø 180 mm trekkende kap met veegluik	127,90	A
1300359	RVS Ø 200 mm trekkende kap met veegluik	140,10	A
1300354	RVS Ø 225 mm trekkende kap met veegluik	244,30	A
1300351	RVS Ø 250 mm trekkende kap met veegluik	169,80	A
1300372	RVS Ø 300 mm trekkende kap met veegluik	189,70	A
1300373	RVS Ø 350 mm trekkende kap met veegluik	207,30	A



Prefab schoorstenen

B&E PREFAB SCHOORSTENEN VOOR ELKE TOEPASSING!

Voor de prefab schoorsteen met verschillende type afvoergassen en ventilatieafvoer, kunnen wij u voorzien van een hoogwaardige oplossing, in elke gewenste maatvoering en model.

Deze prefab schoorstenen zijn in elke bestaande RAL kleur te verkrijgen.



Wij kunnen u van offerte, inmeten, tekeningen, productie en montage voorzien, om u een compleet pakket aan te bieden!

Voor meer info; vraag ons verkoopteam!

verkoop@beig.nl of 035 - 72 009 73

HOOFDSTUK 7

RVS CLV-Systemen

Omschrijving	Pagina
RVS CLV-Systemen Ø 100 / 150 mm - Ø 130 / 200 mm	76
RVS CLV-Systemen Ø 150 / 250 mm - Ø 180 / 280 mm	77
Systeemoverzicht CLV-Systemen	78
RVS CLV-Systemen Ø 200 / 350 mm - Ø 230 / 400 mm	79
RVS CLV-Systemen Ø 250 / 450 mm	80

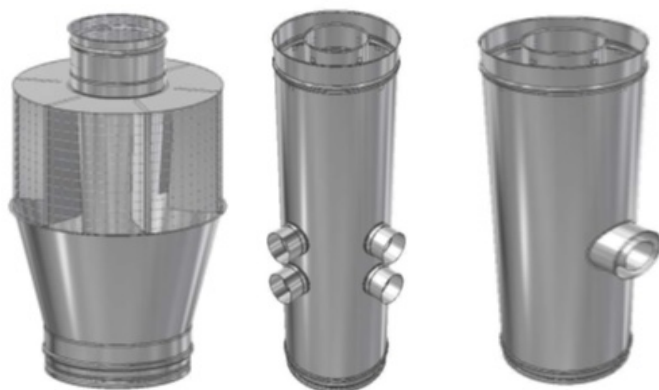

SCHIEDEL

ROOKGASKANALEN

RVS CLV-Systemen

RVS CLV
 Ø 100/150 mm



Artikelnr.	Omschrijving	Brutoprijs	Krt.G
CLV1001	CLV Ø 100/150 mm pijp vast L = 955 mm	117,20	A
CLV1002	CLV Ø 100/150 mm pijp los L = 955 mm	96,80	A
CLV1003	CLV Ø 100/150 mm pijp los L = 455 mm	79,40	A
CLV1004	CLV Ø 100/150 mm pijp los L = 205 mm	66,90	A
CLV1005	CLV Ø 100/150 mm paspijp L = 720-1100mm	262,20	A
CLV1008	CLV Ø 100/150 mm T-Stuk aftakking 2 x Ø 80mm	197,70	A
CLV1009	CLV Ø 100/150 mm T-Stuk aftakking 1 x Ø 80/125mm	200,20	A
CLV1015	CLV Ø 100/150 mm Inspectie T-Stuk + Condensafvoer	363,00	A
CLV1020	CLV Ø 100/150 mm Inspectie vloersteun	49,80	A
CLV1024	CLV Ø 100/150 mm universele beugel	44,10	A
CLV1025	CLV Ø 100/150 mm zware muurbeugel vast 50 mm	48,90	A
CLV1029	CLV Ø 100/150 mm dakplaat platdak 0°	89,60	A
CLV1033	CLV Ø 100/150 mm stormkraag	46,40	A
CLV1034	CLV Ø 100/150 mm dakkap vrije uitmondung	406,30	A
CLV1035	CLV Ø 100/150 mm dakkap	232,70	A

RVS CLV
 Ø 130/200 mm



CLV1301	CLV Ø 130/200 mm pijp vast L = 955 mm	153,50	A
CLV1302	CLV Ø 130/200 mm pijp los L = 955 mm	118,40	A
CLV1303	CLV Ø 130/200 mm pijp los L = 455 mm	85,80	A
CLV1304	CLV Ø 130/200 mm pijp los L = 205 mm	67,90	A
CLV1305	CLV Ø 130/200 mm paspijp L = 720-1100mm	262,60	A
CLV1308	CLV Ø 130/200 mm T-Stuk aftakking 2 x Ø 80mm	197,70	A
CLV1309	CLV Ø 130/200 mm T-Stuk aftakking 1 x Ø 80/125mm	200,20	A
CLV1310	CLV Ø 130/200 mm T-Stuk aft. 4 x Ø 80mm 180°	206,30	A
CLV1311	CLV Ø 130/200 mm T-Stuk aft. 2 x Ø 80/125mm 180°	224,80	A
CLV1312	CLV Ø 130/200 mm T-Stuk aft. 4 x Ø 80mm 90°	206,30	A
CLV1313	CLV Ø 130/200 mm T-Stuk aft. 2 x Ø 80/125mm 90°	224,80	A
CLV1315	CLV Ø 130/200 mm Inspectie T-Stuk + Condensafvoer	404,70	A
CLV1320	CLV Ø 130/200 mm Inspectie vloersteun	60,60	A
CLV1324	CLV Ø 130/200 mm universele beugel	54,80	A
CLV1325	CLV Ø 130/200 mm zware muurbeugel vast 50 mm	50,90	A
CLV1329	CLV Ø 130/200 mm dakplaat platdak 0°	103,20	A
CLV1333	CLV Ø 130/200 mm stormkraag	55,30	A
CLV1334	CLV Ø 130/200 mm dakkap vrije uitmondung	452,60	A
CLV1335	CLV Ø 130/200 mm dakkap	261,20	A

- * In prijslijst staan de standaard artikelen,
- * Overige artikelen en diameters op aanvraag.
- * Projectmatig op aanvraag.

SCHIEDEL



ROOKGASKANALEN

RVS CLV-Systemen

RVS CLV Ø 150/250 mm



Artikelnr.	Omschrijving	Brutoprijs	Krt.G
CLV1501	CLV Ø 150/250 mm pijp vast L = 955 mm	179,80	A
CLV1502	CLV Ø 150/250 mm pijp los L = 955 mm	143,10	A
CLV1503	CLV Ø 150/250 mm pijp los L = 455 mm	103,40	A
CLV1504	CLV Ø 150/250 mm pijp los L = 205 mm	83,00	A
CLV1505	CLV Ø 150/250 mm paspijp L = 720-1100mm	293,60	A
CLV1508	CLV Ø 150/250 mm T-Stuk aftakking 2 x Ø 80mm	226,60	A
CLV1509	CLV Ø 150/250 mm T-Stuk aftakking 1 x Ø 80/125mm	221,50	A
CLV1510	CLV Ø 150/250 mm T-Stuk aft. 4 x Ø 80mm 180°	236,50	A
CLV1511	CLV Ø 150/250 mm T-Stuk aft. 2 x Ø 80/125mm 180°	256,60	A
CLV1512	CLV Ø 150/250 mm T-Stuk aft. 4 x Ø 80mm 90°	236,50	A
CLV1513	CLV Ø 150/250 mm T-Stuk aft. 2 x Ø 80/125mm 90°	256,60	A
CLV1515	CLV Ø 150/250 mm Inspectie T-Stuk + Condensafvoer	449,90	A
CLV1520	CLV Ø 150/250 mm Inspectie vloersteun	68,50	A
CLV1524	CLV Ø 150/250 mm universele beugel	45,10	A
CLV1525	CLV Ø 150/250 mm zware muurbeugel vast 50 mm	55,60	A
CLV1529	CLV Ø 150/250 mm dakplaat platdak 0°	108,60	A
CLV1533	CLV Ø 150/250 mm stormkraag	63,10	A
CLV1534	CLV Ø 150/250 mm dakkap vrije uitmonding	526,60	A
CLV1535	CLV Ø 150/250 mm dakkap	311,50	A

RVS CLV Ø 180/280 mm



CLV1801	CLV Ø 180/280 mm pijp vast L = 955 mm	188,60	A
CLV1802	CLV Ø 180/280 mm pijp los L = 955 mm	155,30	A
CLV1803	CLV Ø 180/280 mm pijp los L = 455 mm	106,30	A
CLV1804	CLV Ø 180/280 mm pijp los L = 205 mm	86,90	A
CLV1805	CLV Ø 180/280 mm paspijp L = 720-1100mm	329,80	A
CLV1808	CLV Ø 180/280 mm T-Stuk aftakking 2 x Ø 80mm	247,10	A
CLV1809	CLV Ø 180/280 mm T-Stuk aftakking 1 x Ø 80/125mm	241,70	A
CLV1810	CLV Ø 180/280 mm T-Stuk aft. 4 x Ø 80mm 180°	254,80	A
CLV1811	CLV Ø 180/280 mm T-Stuk aft. 2 x Ø 80/125mm 180°	275,10	A
CLV1812	CLV Ø 180/280 mm T-Stuk aft. 4 x Ø 80mm 90°	254,80	A
CLV1813	CLV Ø 180/280 mm T-Stuk aft. 2 x Ø 80/125mm 90°	275,10	A
CLV1815	CLV Ø 180/280 mm Inspectie T-Stuk + Condensafvoer	462,90	A
CLV1820	CLV Ø 180/280 mm Inspectie vloersteun	68,90	A
CLV1824	CLV Ø 180/280 mm universele beugel	45,60	A
CLV1825	CLV Ø 180/280 mm zware muurbeugel vast 50 mm	55,60	A
CLV1829	CLV Ø 180/280 mm dakplaat platdak 0°	118,10	A
CLV1833	CLV Ø 180/280 mm stormkraag	67,00	A
CLV1834	CLV Ø 180/280 mm dakkap vrije uitmonding	547,00	A
CLV1835	CLV Ø 180/280 mm dakkap	353,20	A

- * In prijslijst staan de standaard artikelen,
- * Overige artikelen en diameters op aanvraag.
- * Projectmatig op aanvraag.



ROOKGASKANALEN
RVS CLV-Systemen



**VOLLEDIG CLV SYSTEEM
VAN EUROPA'S NUMMER 1
IN RVS RGA
EN LTV KANALEN**

Volledig uit INOX

Exclusief slank design

Concurrerende Prijsstelling

Snel monteerbaar

*Exclusief van Schiedel
NU ook aansluit elementen 60 - 100*



VOOR MEER INFO EN DE PRIJSSTELLING:

B&E Installatie Groothandel
Oude Amersfoortseweg 249 B
1212 AD Hiversum

Tel: 035 – 72 009 73
E-mail: verkoop@beig.nl
www.deinstallatiegroothandel.nl/



ROOKGASKANALEN

RVS CLV-Systemen

RVS CLV Ø 200/350 mm



Artikelnr.	Omschrijving	Brutoprijs	Krt.G
CLV2001	CLV Ø 200/350 mm pijp vast L = 955 mm	230,40	A
CLV2002	CLV Ø 200/350 mm pijp los L = 955 mm	193,70	A
CLV2003	CLV Ø 200/350 mm pijp los L = 455 mm	132,40	A
CLV2004	CLV Ø 200/350 mm pijp los L = 205 mm	94,10	A
CLV2005	CLV Ø 200/350 mm paspijp L = 720-1100mm	370,00	A
CLV2008	CLV Ø 200/350 mm T-Stuk aftakking 2 x Ø 80mm	281,70	A
CLV2009	CLV Ø 200/350 mm T-Stuk aftakking 1 x Ø 80/125mm	273,40	A
CLV2010	CLV Ø 200/350 mm T-Stuk aft. 4 x Ø 80mm 180°	290,80	A
CLV2011	CLV Ø 200/350 mm T-Stuk aft. 2 x Ø 80/125mm 180°	312,90	A
CLV2012	CLV Ø 200/350 mm T-Stuk aft. 4 x Ø 80mm 90°	290,80	A
CLV2013	CLV Ø 200/350 mm T-Stuk aft. 2 x Ø 80/125mm 90°	312,90	A
CLV2015	CLV Ø 200/350 mm Inspectie T-Stuk + Condensafvoer	491,40	A
CLV2020	CLV Ø 200/350 mm Inspectie vloersteun	69,30	A
CLV2024	CLV Ø 200/350 mm universele beugel	46,70	A
CLV2025	CLV Ø 200/350 mm zware muurbeugel vast 50 mm	68,40	A
CLV2029	CLV Ø 200/350 mm dakplaat platdak 0°	152,00	A
CLV2033	CLV Ø 200/350 mm stormkraag	77,80	A
CLV2034	CLV Ø 200/350 mm dakkap vrije uitmonding	629,30	A
CLV2035	CLV Ø 200/350 mm dakkap	378,00	A

RVS CLV Ø 230/400 mm



CLV2301	CLV Ø 230/400 mm pijp vast L = 955 mm	267,70	A
CLV2302	CLV Ø 230/400 mm pijp los L = 955 mm	215,60	A
CLV2303	CLV Ø 230/400 mm pijp los L = 455 mm	142,90	A
CLV2304	CLV Ø 230/400 mm pijp los L = 205 mm	103,70	A
CLV2305	CLV Ø 230/400 mm paspijp L = 720-1100mm	402,50	A
CLV2308	CLV Ø 230/400 mm T-Stuk aftakking 2 x Ø 80mm	305,70	A
CLV2309	CLV Ø 230/400 mm T-Stuk aftakking 1 x Ø 80/125mm	312,10	A
CLV2310	CLV Ø 230/400 mm T-Stuk aft. 4 x Ø 80mm 180°	314,00	A
CLV2311	CLV Ø 230/400 mm T-Stuk aft. 2 x Ø 80/125mm 180°	351,80	A
CLV2312	CLV Ø 230/400 mm T-Stuk aft. 4 x Ø 80mm 90°	314,00	A
CLV2313	CLV Ø 230/400 mm T-Stuk aft. 2 x Ø 80/125mm 90°	351,80	A
CLV2315	CLV Ø 230/400 mm Inspectie T-Stuk + Condensafvoer	546,50	A
CLV2320	CLV Ø 230/400 mm Inspectie vloersteun	80,50	A
CLV2324	CLV Ø 230/400 mm universele beugel	47,20	A
CLV2325	CLV Ø 230/400 mm zware muurbeugel vast 50 mm	85,60	A
CLV2329	CLV Ø 230/400 mm dakplaat platdak 0°	160,60	A
CLV2333	CLV Ø 230/400 mm stormkraag	85,00	A
CLV2334	CLV Ø 230/400 mm dakkap vrije uitmonding	683,40	A
CLV2335	CLV Ø 230/400 mm dakkap	425,50	A

- * In prijslijst staan de standaard artikelen,
- * Overige artikelen en diameters op aanvraag.
- * Projectmatig op aanvraag.



ROOKGASKANALEN

RVS CLV-Systemen

RVS CLV
 Ø 250/450 mm



Artikelnr.	Omschrijving	Brutoprijs	Krt.G
CLV2501	CLV Ø 250/450 mm pijp vast L = 955 mm	291,40	A
CLV2502	CLV Ø 250/450 mm pijp los L = 955 mm	243,50	A
CLV2503	CLV Ø 250/450 mm pijp los L = 455 mm	153,00	A
CLV2504	CLV Ø 250/450 mm pijp los L = 205 mm	112,50	A
CLV2505	CLV Ø 250/450 mm paspijp L = 720-1100mm	457,50	A
CLV2508	CLV Ø 250/450 mm T-Stuk aftakking 2 x Ø 80mm	351,80	A
CLV2509	CLV Ø 250/450 mm T-Stuk aftakking 1 x Ø 80/125mm	345,80	A
CLV2510	CLV Ø 250/450 mm T-Stuk aft. 4 x Ø 80mm 180°	357,40	A
CLV2511	CLV Ø 250/450 mm T-Stuk aft. 2 x Ø 80/125mm 180°	379,80	A
CLV2512	CLV Ø 250/450 mm T-Stuk aft. 4 x Ø 80mm 90°	357,40	A
CLV2513	CLV Ø 250/450 mm T-Stuk aft. 2 x Ø 80/125mm 90°	379,80	A
CLV2515	CLV Ø 250/450 mm Inspectie T-Stuk + Condensafvoer	573,70	A
CLV2520	CLV Ø 250/450 mm Inspectie vloersteun	88,60	A
CLV2524	CLV Ø 250/450 mm universele beugel	47,70	A
CLV2525	CLV Ø 250/450 mm zware muurbeugel vast 50 mm	107,40	A
CLV2529	CLV Ø 250/450 mm dakplaat platdak 0°	167,50	A
CLV2533	CLV Ø 250/450 mm stormkraag	100,70	A
CLV2534	CLV Ø 250/450 mm dakkap vrije uitmonding	830,80	A
CLV2535	CLV Ø 250/450 mm dakkap	474,60	A



- * In prijslijst staan de standaard artikelen,
- * Overige artikelen en diameters op aanvraag.
- * Projectmatig op aanvraag.



HOOFDSTUK 8

Kachelaccessoires en Veegmaterialen







Omschrijving	Pagina
Hittebestendige verf-Glasreiniger-kachelkit-kachelpoets-rookpatronen-Koord	82
Nisbussen gegalvaniseerd-Isolatiemateriaal-Flexim	82
Tape-Vonkengaas-Klepsleutel-Micaglas-Stookrooster-Pumicaplaten-Ecofan vent.	83
Veegmaterialen	84



Galafire T 400

ROOKGASKANALEN

Kachelaccessoires

	Artikelnr.	Omschrijving	Brutoprijs	Krt.G
Hittebestendige Verf 	5900010	Spuitbus Hittebestendige verf 650°C zwart 400 ml	12,90	A
	5900020	Spuitbus Hittebestendige verf 650°C antraciet 400 ml	12,90	A
	5900030	Spuitbus Hittebestendige verf 650°C Donk. Antr. 400 ml	12,90	A
	5900040	Spuitbus Hittebestendige verf 650° C gietijzer 400 ml	14,00	A
	5900170	Spuitbus hittebestendige verf 800°C Ral 9005 400ml	28,00	A
	5900035	Spuitbus hittebestendige verf f.b.v. Prima Smooth 400ml	26,30	A
Glasreiniger Kachelkit 	5900050	Glasreiniger Spray 450 ml	10,00	A
	5900060	Glasreiniger navulling 850 ml	11,50	A
	5900070	Kachelkit Granita potje 500 gram	8,30	A
	5900080	Kachelkit Granita koker 600 gram	13,20	A
	5900075	Griffon Hydra vuurvaste kit pot 750 gram	13,50	A
	5900110	Speksteenkit koker	11,50	A
5900085	Silconenkit 300° koker 310 ml	30,60	A	
Kachelpoets	5900090	Black Polish Potje 200 ml kachelpoets	11,50	A
Rookpatronen	5900120	Rookpatronen 65 sec. doos 10 stuks	29,70	A
Koord 	5900100	Alsiflex isolatiekoord zelfklevend 10 x 2 mm BxH p/mtr	2,20	A
	5900115	Alsiflex isolatiekoord zelfklevend 8 x 3 mm BxH p/mtr	2,20	A
	5900125	Alsiflex isolatiekoord zelfklevend 15 x 2 mm BxH p/mtr	2,90	A
GlasvezelKoord 	5900195	Glasvezelkoord Ø 6 mm zwart L=5mtr + tube lijm	16,10	A
	5900175	Glasvezelkoord Ø 8 mm zwart L=5mtr + tube lijm	19,20	A
	5900180	Glasvezelkoord Ø 10 mm zwart L=5mtr + tube lijm	19,60	A
	5900183	Tube lijm 70 ml voor Glasvezelkoord	7,50	A
Nisbussen Gegalvaniseerd 	5900205	Nisbus Ø 100 mm gegalvaniseerd	10,90	A
	5900220	Nisbus Ø 120 mm gegalvaniseerd	18,60	A
	5900230	Nisbus Ø 125 mm gegalvaniseerd	25,80	A
	5900200	Nisbus Ø 150 mm gegalvaniseerd	11,90	A
	5900241	Nisbus Ø 180 mm gegalvaniseerd	28,50	A
	5900240	Nisbus Ø 200 mm gegalvaniseerd	34,00	A
	5900242	Nisbusdeksel Ø 100-111 mm gegalvaniseerd	3,10	A
	5900243	Nisbusdeksel Ø 125-130 mm gegalvaniseerd	3,50	A
	5900244	Nisbusdeksel Ø 150 mm gegalvaniseerd	3,70	A
	5900247	Nisbusdeksel Ø 180 mm gegalvaniseerd	6,00	A
	5900248	Nisbusdeksel Ø 200 mm gegalvaniseerd	10,40	A
	Isolatie Materiaal 	5900140	Vermiculite No3 zak 100 liter	38,70
5900165		Vermiculite met mortel No3 Zak 50 liter	36,10	A
5900190		Perlite Nr. A zak 100 liter	26,80	A
5900157		Superwool plus glas deken L = 14640 mm dikte = 13 mm	117,00	A
5900155		Superwool plus glas deken L = 7320 mm dikte = 25 mm	111,60	A
5900161		Trekband Aluminium L = 850 mm (10 stuks)	13,00	A
5900159		Trekband Aluminium L = 850 mm (50 stuks)	64,00	A
Flexim 		2100810	Flexim Dakmortel Zwart doos 20 ltr	99,90
	2100820	Flexim Dakmortel Grijs doos 20 ltr	99,90	A
	2100830	Flexim Dakmortel Rood doos 20 ltr	99,90	A



ROOKGASKANALEN







Kachelaccessoires

	Artikelnr.	Omschrijving	Brutoprijs	Krt.G
Tape	3600420	Aluminium tape 50 mm Rol 50 meter	26,00	A
	5900160	Flashband 75 mm Rol 10 meter	18,00	A
	5900150	Flashband 150 mm Rol 10 meter	22,00	A
Vonkengas	5900145	Vonkengas 8 mm 100 x 30 cm	30,50	A
Klepsleutel	1500490	Blauw gegloeid Ø 100 - 111 mm Klepsleutel	13,80	A
	1500491	Blauw gegloeid Ø 125 - 131 mm Klepsleutel	15,80	A
	1500492	Blauw gegloeid Ø 150 mm Klepsleutel	17,10	A
	1500493	Blauw gegloeid Ø 180 mm Klepsleutel	19,30	A
	1500494	Blauw gegloeid Ø 200 mm Klepsleutel	21,30	A
Micaglas	5900300	Micaglas gevlekt 120 x 120 mm	13,30	A
	5900340	Micaglas gevlekt 150 x 150 mm	24,90	A
	5900350	Micaglas gevlekt 180 x 180 mm	34,50	A
	5900360	Micaglas gevlekt 200 x 100 mm	18,90	A
	5900370	Micaglas gevlekt 250 x 250 mm	109,50	A
Stookroosters	5900400	Stookrooster 7 tands 440 x 350 mm (BxD)	191,00	A
	5900410	Stookrooster 7 tands 550 x 350 mm (BxD)	204,40	A
	5900420	Stookrooster 9 tands 670 x 350 mm (BxD)	264,00	A
	5900430	Stookrooster 12 tands 840 x 350 mm (BxD)	339,10	A
Diversen	5900275	Galafire thermometer magnetisch	13,60	A
	5900280	Brandblusser Fireater 8 B	152,00	A
	7700040	Houtvochtigheidsmeter + Batterij	41,40	A
Isolatieplaten	5900610	Pumicaplaat 1000 x 760 x 20 mm	62,50	A
	5900620	Pumicaplaat 1000 x 760 x 25 mm	75,60	A
	5900630	Pumicaplaat 1000 x 760 x 30 mm	89,10	A
	5900640	Pumicaplaat 1000 x 760 x 40 mm	113,10	A
	5900650	Calcon Isolatieplaat 1000 x 625 x 25 mm	40,10	A
	5900660	Calcon Isolatieplaat 1000 x 625 x 30 mm	48,00	A
	5900665	Calcon Isolatieplaat 1000 x 625 x 40 mm	60,20	A
	5900670	Calcon Isolatieplaat 1000 x 625 x 50 mm	76,30	A
	5900690	Calcon Gluecon lijm 1000 koker 300 ml	28,20	A
Galafire Ventilatoren	5900780	Galafire Fan 4-blad	89,80	A
	5900790	Galafire T 400	108,70	A



ROOKGASKANALEN

Veegmaterialen

	Artikelnr.	Omschrijving	Brutoprijs	Krt.G
Veegstokken 	5920010	Flexibele veegstok + schoefdraad PRO L=1000 mm groen	18,40	A
	5920020	Flexibele veegstok + schoefdraad DHZ L=1000 mm rood	9,50	A
	5920015	Flexibele veegstok schoefdraad budget L=1200 mm blauw	13,20	A
	5920030	Flexibele veegstok + schoefdraad DHZ L=1200 mm zwart	6,80	A
	5920050	Flexibele Veer universeel voor schoorsteenstok	11,00	A
Nylonborstels 	5920100	Schoorsteenveeg nylonborstel rond Ø 80 mm	19,00	A
	5920110	Schoorsteenveeg nylonborstel rond Ø 125 mm	19,00	A
	5920120	Schoorsteenveeg nylonborstel rond Ø 150 mm	19,00	A
	5920130	Schoorsteenveeg nylonborstel rond Ø 180 mm	19,00	A
	5920140	Schoorsteenveeg nylonborstel rond Ø 200 mm	19,00	A
	5920150	Schoorsteenveeg nylonborstel rond Ø 250 mm	21,90	A
	5920160	Schoorsteenveeg nylonborstel rond Ø 300 mm	23,20	A
	Staalborstels 	5920200	Staalborstel rond Ø 125 mm	15,90
5920210		Staalborstel rond Ø 150 mm	15,90	A
5920220		Staalborstel rond Ø 180 mm	15,90	A
5920230		Staalborstel rond Ø 200 mm	17,00	A
5920240		Staalborstel rond Ø 250 mm	17,00	A
5920250		Staalborstel rond Ø 300 mm	19,50	A
Bolveegset		5920300	Bolveegset Ø 150 mm nylon compleet met touw	50,30
	5920301	Bolveegset Ø 150 mm staal compleet met touw	47,30	A
	5920310	Bolveegset Ø 200 mm nylon compleet met touw	50,30	A
	5920311	Bolveegset Ø 200 mm staal compleet met touw	48,50	A
Kogelveegset 	5920340	Kogelveegset Ø 150 mm zonder touw	99,50	A
	5920350	Kogelveegset Ø 200 mm zonder touw	103,60	A
	5920360	Kogelveegset Ø 250 mm zonder touw	105,40	A
	5920370	Kogelveegset Ø 300 mm zonder touw	109,60	A
Draadster 	5920400	Draadster Ø 150 mm	16,20	A
	5920410	Draadster Ø 200 mm	17,60	A
	5920420	Draadster Ø 250 mm	18,20	A
	5920430	Draadster Ø 300 mm	19,60	A
Aszuiger	5900320	Aszuiger zonder motor 18 Liter groen	52,60	A
	5900330	Aszuiger met motor 18 Liter zwart	101,80	A
Onderdelen 	5920440	Harpsluiting voor schroef-oog groot	3,50	A
	5920450	Schroef-oog voor losse borstel	4,70	A
	5920460	Losse kogel voor veegset gewicht 1 Kg	20,70	A
	5920461	Losse kogel voor veegset gewicht 2 Kg	32,90	A
	5920470	Touw voor kogelveegset L = 10 meter	4,00	A
	5920480	Ontstoppingsboor voor stok	20,70	A



HOOFDSTUK 9

Onderdelen inbouw openhaarden

Omschrijving	Pagina
Onderdelen inbouw openhaarden type HF type 55 cm - 65 cm - 70 cm Front	86
Onderdelen inbouw openhaarden type Multiwall 60 cm - 70 cm / Rookkappen / Verlopen	87
Aantekeningen	88



ROOKGASKANALEN

Onderdelen inbouw openhaarden type HF

Artikelnr.	Omschrijving	Brutoprijs	Krt.G
------------	--------------	------------	-------

HF type 55 cm front model

HF type 55
Front



5930010	Front 55 cm rugwand grijs	299,30	A
5930020	Front 55 cm stookstenen grijs	95,10	A
5930030	Front 55 cm rookkap naar Ø 200 mm	286,10	A
5930040	Front 55 cm vuurkorf 116/13	385,00	A
5930050	Front 55 cm vuurkorf 116/5	436,50	A
5930060	Front 55 cm luchttoevoerplaat Ø 150 mm	173,30	A

HF type 65 cm front model

HF type 65
Front



5930070	Front 65 cm rugwand grijs	315,00	A
5930080	Front 65 cm stookstenen grijs	105,50	A
5930090	Front 65 cm rookkap naar Ø 200 mm	306,90	A
5930100	Front 65 cm vuurkorf 116/13	473,60	A
5930110	Front 65 cm vuurkorf 116/5	524,90	A
5930120	Front 65 cm luchttoevoerplaat Ø 150 mm	180,90	A

HF type 70 cm front model

HF type 70
Front



5930130	Front 70 cm rugwand grijs	533,40	A
5930140	Front 70 cm stookstenen grijs	173,50	A
5930150	Front 70 cm rookkap naar Ø 250 mm	577,30	A
5930160	Front 70 cm vuurkorf 116/13	678,40	A
5930170	Front 70 cm vuurkorf 116/5	738,10	A
5930180	Front 70 cm luchttoevoerplaat Ø 150 mm	191,70	A



ROOKGASKANALEN

Onderdelen inbouw openhaarden type HF

Artikelnr.	Omschrijving	Brutoprijs	Krt.G
------------	--------------	------------	-------

Multiwall 60 cm

Multiwall
60 cm

5930200	Multiwall 60 cm achterwand grijs type HF	299,30	A
5930210	Multiwall 60 - 70 cm zijwand grijs type HF	165,00	A
5930220	Multiwall 60 cm rookkap naar Ø 200 mm type HF	304,50	A
5930230	Multiwall 60 cm luchttoevoerplaat Ø 150 mm type HF	177,90	A

Multiwall 70 cm

Multiwall
70 cm

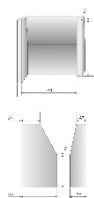

5930240	Multiwall 70 cm achterwand grijs type HF	320,80	A
5930210	Multiwall 60 - 70 cm zijwand grijs type HF	165,00	A
5930250	Multiwall 70 cm stookstenen grijs type HF	125,00	A
5930260	Multiwall 70 cm rookkap naar Ø 200 mm type HF	327,80	A
5930270	Multiwall 75 cm rookkap naar Ø 200 mm type HF	428,80	A
5930280	Multiwall 70 cm luchttoevoerplaat Ø 150 mm type HF	188,60	A
5930285	Multiwall 70 cm HOOG achterwand grijs type HF	407,80	A
5930290	Multiwall 70 cm HOOG zijwand grijs type HF	165,00	A
5930295	Multiwall 70 cm HOOG rookkap naar Ø 250 mm type HF	497,80	A

Multiwall Rookkappen

Multiwall
Rookkappen



5930220	Multiwall 60 cm rookkap naar Ø 200 mm type HF	304,50	A
5930260	Multiwall 70 cm rookkap naar Ø 200 mm type HF	327,90	A
5930295	Multiwall 70 cm HOOG rookkap naar Ø 250 mm type HF	497,80	A
5930270	Multiwall 75 cm rookkap naar Ø 200 mm type HF	428,80	A
5930300	Multiwall 85 cm rookkap naar Ø 250 mm type HF	414,00	A
5930310	Multiwall 100 cm rookkap naar Ø 350 mm type HF	503,00	A

Reducerende verlopen voor rookkappen

Verlopen
Rookkappen



5930320	Rookkap verloop Ø 200 - Ø 150 mm type HF	70,50	A
5930330	Rookkap verloop Ø 200 - Ø 175 mm type HF	42,90	A
5930340	Rookkap verloop Ø 200 - Ø 180 mm type HF	44,70	A
5930350	Rookkap verloop Ø 200 - Ø 250 mm type HF	78,70	A
5930360	Rookkap verloop Ø 250 - Ø 180 mm type HF	78,70	A
5930370	Rookkap verloop Ø 250 - Ø 200 mm type HF	53,60	A
5930380	Rookkap verloop Ø 250 - Ø 300 mm type HF	78,70	A
5930390	Rookkap verloop Ø 350 - Ø 250 mm type HF	99,60	A
5930400	Rookkap verloop Ø 350 - Ø 300 mm type HF	99,60	A



HOOFDSTUK 10

Ventilatiekanalen Gegalvaniseerd en Kunststof

Omschrijving	Pagina
Spiralo Ventilatiekanaal Ø 80 mm - Ø 100 mm	90
Spiralo Ventilatiekanaal Ø 125 mm - SAFE Ø 125 mm	91
Spiralo Ventilatiekanaal Ø 150 mm - SAFE Ø 150 mm	92
Spiralo Ventilatiekanaal Ø 160 mm - SAFE Ø 160 mm	93
Spiralo Ventilatiekanaal Ø 180 mm - SAFE Ø 180mm	95
Spiralo Ventilatiekanaal Ø 200 mm - SAFE Ø 200 mm	96
Spiralo Ventilatiekanaal Ø 250 mm - Ø 300 mm	97
Spiralo Ventilatiekanaal Ø 300 mm (vervolg) - Ø 315 mm	98
Spiralo Ventilatiekanaal Ø 355 mm - Ø 400 mm - Ø 450 mm	99
Spiralo Ventilatiekanaal Ø 500 mm - Ø 560 mm - Ø 6000 mm - Ø 630 mm	100
Kunststof Ventilatiekanaal 110 x 54 mm - 204 x 60 mm - 220 x 90 mm	101
Kunststof Ventilatiekanaal Eco + 220 x 90 mm - 169 x 77 mm - Buitenroosters	103
Kunststof Ventilatiekanaal Ø 100 mm - Ø 125 mm - Ø 150 mm	104
Instortkanaal Gegalvaniseerd 170 / 70 mm - 220 / 80 mm	105



VENTILATIEKANALEN

Spiralo Ventilatiekanalen Gegalvaniseerd

Spiralo
 Ø 80 mm
 Luchtkanalen



Artikelnr.	Omschrijving	Brutoprijs	Krt.G
3401020	Spiralo buis sendz. Ø 80 mm L=3000 mm	19,90	A
3410538	Spiralo verbindingsstuk tbv buis Ø 80 mm	3,00	A
3410563	Spiralo verbindingsstuk tbv hulpstuk Ø 80 mm	3,00	A
3410005	Spiralo gladde bocht 45° Ø 80 mm	9,60	A
3410007	Spiralo gladde bocht 90° Ø 80 mm	10,80	A
3413080	Spiralo plooi-bocht 45° Ø 80 mm	4,50	A
3413010	Spiralo plooi-bocht 90° Ø 80 mm	6,60	A
3410098	Spiralo geperst T-stuk 90° Ø 80 mm	20,30	A
3410195	Spiralo T-stuk 45° Ø 80 mm	47,40	A
3410214	Spiralo zadelstuk 90° Ø 80 buis Ø 80 mm	6,60	A
3410216	Spiralo zadelstuk 90° Ø 80 buis Ø 100 mm	6,60	A
3410218	Spiralo zadelstuk 90° Ø 80 buis Ø 112 - 140 mm	6,60	A
3410222	Spiralo zadelstuk 90° Ø 80 buis Ø 150 - 160 mm	6,60	A
3410228	Spiralo zadelstuk 90° Ø 80 buis Ø 180 - 200 mm	6,60	A
3410235	Spiralo zadelstuk 90° Ø 80 buis Ø 224 - 315 mm	6,60	A
3410275	Spiralo zadelstuk 45° Ø 80 mm buis Ø 80 mm	18,00	A
3410277	Spiralo zadelstuk 45° buis Ø 112 - 140 mm	18,00	A
3410333	Spiralo boordring Ø 80 mm H = 65 mm	4,00	A
3410462	Spiralo kort verloopstuk Ø 100 - 80 mm	9,20	A
3410463	Spiralo kort verloopstuk Ø 125 - 80 mm	9,20	A
3410461	Spiralo kort verloopstuk Ø 150 - 80 mm	23,00	A
3410467	Spiralo kort verloopstuk Ø 160 - 80 mm	9,60	A
3410604	Spiralo buisdeksel Ø 80 mm	3,30	A
3410701	Spiralo regelklep Ø 80 mm	27,10	A
3414604	Spiralo verzinkte beugel Ø 80 mm	3,50	A

Spiralo
 Ø 100 mm
 Luchtkanalen



3401050	Spiralo buis sendz Ø 100 mm L=3000 mm	24,60	A
3410539	Spiralo verbindingsstuk tbv buis Ø 100 mm	3,00	A
3410564	Spiralo verbindingsstuk tbv hulpstuk Ø 100 mm	3,00	A
3410010	Spiralo gladde bocht 45° Ø 100 mm	9,10	A
3410012	Spiralo gladde bocht 90° Ø 100 mm	10,30	A
3413090	Spiralo plooi-bocht 45° Ø 100 mm	5,00	A
3413020	Spiralo plooi-bocht 90° Ø 100 mm	7,10	A
3410100	Spiralo geperst T-stuk 90° Ø 100 mm	15,10	A
3410197	Spiralo T-stuk 45° Ø 100 mm	52,30	A
3410217	Spiralo zadelstuk 90° Ø 100 buis Ø 100mm	6,30	A
3410219	Spiralo zadelstuk 90° Ø 100 buis Ø 112 - 140 mm	6,30	A
3410223	Spiralo zadelstuk 90° Ø 100 buis Ø 150 - 160 mm	6,30	A
3410229	Spiralo zadelstuk 90° Ø 100 buis Ø 180 - 200 mm	6,30	A
3410236	Spiralo zadelstuk 90° Ø 100 buis Ø 224 - 250 mm	6,30	A
3410244	Spiralo zadelstuk 90° Ø 100 buis Ø 280 - 355 mm	6,30	A
3410276	Spiralo zadelstuk 45° Ø 100 mm buis Ø 100 mm	19,80	A
3410278	Spiralo zadelstuk 45° buis Ø 112 - 140 mm	19,80	A
3410334	Spiralo boordring Ø 100mm H = 65 mm	4,00	A
3410462	Spiralo kort verloopstuk Ø 100 - 80 mm	9,20	A
3410464	Spiralo kort verloopstuk Ø 125 - 100 mm	9,20	A
3410465	Spiralo kort verloopstuk Ø 150 - 100 mm	10,80	A
3410468	Spiralo kort verloopstuk Ø 160 - 100 mm	9,60	A
3410471	Spiralo kort verloopstuk Ø 180 - 100 mm	12,50	A
3410475	Spiralo kort verloopstuk Ø 200 - 100 mm	16,60	A
3410605	Spiralo buisdeksel Ø 100 mm	3,30	A
3410702	Spiralo regelklep Ø 100 mm	25,10	A
3414605	Spiralo verzinkte beugel Ø 100 mm	3,60	A

* Spiralo SAFE kanalen Ø 80 en Ø 100 mm op aanvraag

VENTILATIEKANALEN

Spiralo Ventilatiekanalen Gegalvaniseerd

Spiralo
Ø 125 mm
Luchtkanalen



Artikelnr.	Omschrijving	Brutoprijs	Krt.G
3401080	Spiralo buis sendz. Ø 125 mm L=3000 mm	27,90	A
3410540	Spiralo verbindingsstuk tbv buis Ø 125 mm	2,90	A
3410565	Spiralo verbindingsstuk tbv hulpstuk Ø 125 mm	2,90	A
3410014	Spiralo gladde bocht 30° Ø 125 mm	11,90	A
3410015	Spiralo gladde bocht 45° Ø 125 mm	10,40	A
3410017	Spiralo gladde bocht 90° Ø 125 mm	13,40	A
3413100	Spiralo plooi bocht 45° Ø 125 mm	5,50	A
3413030	Spiralo plooi bocht 90° Ø 125 mm	7,10	A
3410016	Spiralo haakse bocht 90° Ø 125 mm	16,00	A
3410101	Spiralo T-stuk 90° Ø 125 mm spruit Ø 80 mm	20,30	A
3410102	Spiralo T-stuk 90° Ø 125 mm spruit Ø 100 mm	16,70	A
3410103	Spiralo geperst T-stuk 90° Ø 125 mm	16,70	A
3410200	Spiralo T-stuk 45° Ø 125 mm	63,10	A
3410220	Spiralo zadelstuk 90° Ø 125 mm buis Ø 125 mm	7,70	A
3410224	Spiralo zadelstuk 90° Ø 125 mm buis Ø 140 - 160 mm	7,70	A
3410230	Spiralo zadelstuk 90° Ø 125 mm buis Ø 180 - 200 mm	7,70	A
3410237	Spiralo zadelstuk 90° Ø 125 mm buis Ø 224 - 250 mm	7,70	A
3410245	Spiralo zadelstuk 90° Ø 125 mm buis Ø 280 - 355 mm	7,70	A
3410279	Spiralo zadelstuk 45° Ø 125 mm buis Ø 125 mm	21,30	A
3410280	Spiralo zadelstuk 45° spruit Ø 125 mm op buis Ø 150 mm	21,30	A
3410335	Spiralo boordring Ø 125 mm H=65 mm	4,50	A
3410329	Spiralo montagebus met lippen Ø 125 mm	8,60	A
3410463	Spiralo kort verloopstuk Ø 125 - Ø 80 mm	9,20	A
3410464	Spiralo kort verloopstuk Ø 125 - Ø 100 mm	9,20	A
3410466	Spiralo kort verloopstuk Ø 150 - Ø 125 mm	9,60	A
3410469	Spiralo kort verloopstuk Ø 160 - Ø 125 mm	9,60	A
3410472	Spiralo kort verloopstuk Ø 180 - Ø 125 mm	12,50	A
3410476	Spiralo kort verloopstuk Ø 200 - Ø 125 mm	14,60	A
3410484	Spiralo kort verloopstuk Ø 250 - Ø 125 mm	19,90	A
3410606	Spiralo buisdeksel Ø 125 mm	3,80	A
3410661	Spiralo deflectorkap Ø 125 mm	243,00	A
3410703	Spiralo regelklep Ø 125 mm	26,80	A
3414606	Spiralo verzinkte beugel Ø 125 mm	3,70	A

Spiralo SAFE
Ø 125 mm
Luchtkanalen



3410540S	Spiralo SAFE verbindingsstuk tbv buis Ø 125 mm	4,80	A
3410014S	Spiralo SAFE gladde bocht 30° Ø 125 mm	16,10	A
3410015S	Spiralo SAFE gladde bocht 45° Ø 125 mm	14,40	A
3410017S	Spiralo SAFE gladde bocht 90° Ø 125 mm	17,20	A
3413100S	Spiralo SAFE plooi bocht 45° Ø 125 mm	7,40	A
3413030S	Spiralo SAFE plooi bocht 90° Ø 125 mm	11,90	A
3410103S	Spiralo SAFE T-stuk 90° Ø 125 mm	22,50	A
3410335S	Spiralo SAFE boordring Ø 125 mm H=65 mm	6,00	A
3410463S	Spiralo SAFE verloopstuk hulpst./buis Ø 125 - Ø 80 mm	11,10	A
3410464S	Spiralo SAFE verloopstuk hulpst./buis Ø 125 - Ø 100 mm	11,10	A
3410466S	Spiralo SAFE verloopstuk hulpst./buis Ø 150 - Ø 125 mm	12,60	A
3410469S	Spiralo SAFE verloopstuk hulpst./buis Ø 160 - Ø 125 mm	12,60	A
3410472S	Spiralo SAFE verloopstuk hulpst./buis Ø 180 - Ø 125 mm	14,30	A
3410476S	Spiralo SAFE verloopstuk hulpst./buis Ø 200 - Ø 125 mm	14,30	A
3410484S	Spiralo SAFE verloopstuk hulpst./buis Ø 250 - Ø 125 mm	15,40	A
3410703S	Spiralo SAFE regelklep Ø 125 mm	38,40	A

* Overige Spiralo Safe materialen Ø 125 mm op aanvraag

VENTILATIEKANALEN

Spiralo Ventilatiekanalen Gegalvaniseerd

Spiralo
Ø 150 mm
Luchtkanalen



Artikelnr.	Omschrijving	Brutoprijs	Krt.G
3401100	Spiralo buis sendz. Ø 150 mm L=3000 mm	38,00	A
3410541	Spiralo verbindingstuk tbv buis Ø 150 mm	3,40	A
3410566	Spiralo verbindingstuk tbv hulpstuk Ø 150 mm	3,40	A
3410019	Spiralo gladde bocht 30° Ø 150 mm	15,90	A
3410020	Spiralo gladde bocht 45° Ø 150 mm	14,00	A
3410022	Spiralo gladde bocht 90° Ø 150 mm	18,70	A
3413110	Spiralo plooi bocht 45° Ø 150 mm	7,10	A
3413040	Spiralo plooi bocht 90° Ø 150 mm	11,10	A
3410105	Spiralo T-stuk 90° Ø 150mm spruit Ø 100 mm	22,70	A
3410106	Spiralo T-stuk 90° Ø 150mm spruit Ø 125 mm	26,00	A
3410107	Spiralo geperst T-stuk 90° Ø 150 mm	26,00	A
3410203	Spiralo T-stuk 45° Ø 150 mm	64,60	A
3410221	Spiralo zadelstuk 90° Ø 150 mm buis Ø 150 mm	10,80	A
3410225	Spiralo zadelstuk 90° Ø 150 mm buis Ø 160 mm	10,80	A
3410231	Spiralo zadelstuk 90° Ø 150 mm buis Ø 180 - 200 mm	10,80	A
3410238	Spiralo zadelstuk 90° Ø 150 mm buis Ø 224 - 250 mm	10,80	A
3410246	Spiralo zadelstuk 90° Ø 150 mm buis Ø 280 - 355 mm	10,80	A
3410286	Spiralo zadelstuk 45° spruit Ø 150 mm op buis Ø 200 mm	22,70	A
3410291	Spiralo zadelstuk 45° spruit Ø 150 mm op buis Ø 250 mm	22,70	A
3410297	Spiralo zadelstuk 45° spruit Ø 150 mm op buis Ø 315 mm	22,70	A
3410336	Spiralo boordring Ø 150 mm H=65 mm	5,90	A
3410465	Spiralo kort verloopstuk Ø 150 - Ø 100 mm	10,80	A
3410466	Spiralo kort verloopstuk Ø 150 - Ø 125 mm	9,60	A
3410607	Spiralo buisdeksel Ø 150 mm	4,20	A
3410662	Spiralo deflectorkap Ø 150 mm	262,20	A
3410704	Spiralo regelklep Ø 150 mm	29,00	A
3414607	Spiralo verzinkte beugel Ø 150 mm	4,30	A

Spiralo SAFE
Ø 150 mm
Luchtkanalen



3410541S	Spiralo SAFE verbindingstuk tbv buis Ø 150 mm	5,90	A
3410019S	Spiralo SAFE gladde bocht 30° Ø 150 mm	20,40	A
3410020S	Spiralo SAFE gladde bocht 45° Ø 150 mm	18,10	A
3410022S	Spiralo SAFE gladde bocht 90° Ø 150 mm	23,10	A
3410107S	Spiralo SAFE T-stuk 90° Ø 150 mm	32,20	A
3410336S	Spiralo SAFE boordring Ø 150 mm H=65 mm	6,40	A
3410465S	Spiralo SAFE verloopstuk hulpst./buis Ø 150 - Ø 100 mm	12,30	A
3410466S	Spiralo SAFE verloopstuk hulpst./buis Ø 150 - Ø 125 mm	12,60	A
3410704S	Spiralo SAFE regelklep Ø 150 mm	38,40	A

* Overige Spiralo Safe materialen Ø 150 mm op aanvraag



VENTILATIEKANALEN

Spiralo Ventilatiekanalen Gegalvaniseerd

Spiralo
Ø 160 mm
Luchtkanalen



Artikelnr.	Omschrijving	Brutoprijs	Krt.G
3401120	Spiralo buis sendz. Ø 160 mm L=3000 mm	45,70	A
3410542	Spiralo verbindingsstuk tbv buis Ø 160 mm	3,60	A
3410567	Spiralo verbindingsstuk tbv hulpstuk Ø 160 mm	3,60	A
3410024	Spiralo gladde bocht 30° Ø 160 mm	15,80	A
3410025	Spiralo gladde bocht 45° Ø 160 mm	13,90	A
3410027	Spiralo gladde bocht 90° Ø 160 mm	18,80	A
3413120	Spiralo plooi-bocht 45° Ø 160 mm	11,40	A
3413050	Spiralo plooi-bocht 90° Ø 160 mm	14,90	A
3410112	Spiralo geperst T-stuk 90° Ø 160 mm	26,60	A
3410108	Spiralo T-stuk 90° Ø 160 mm spruit Ø 80 mm	22,80	A
3410109	Spiralo T-stuk 90° Ø 160 mm spruit Ø 100 mm	22,30	A
3410110	Spiralo T-stuk 90° Ø 160 mm spruit Ø 125 mm	25,00	A
3410111	Spiralo T-stuk 90° Ø 160 mm spruit Ø 150 mm	26,60	A
3410205	Spiralo T-stuk 45° Ø 160 mm	64,70	A
3410226	Spiralo zadelstuk 90° Ø 160 mm buis Ø 160 mm	10,40	A
3410232	Spiralo zadelstuk 90° Ø 160 mm buis Ø 180 - 200 mm	10,40	A
3410239	Spiralo zadelstuk 90° Ø 160 mm buis Ø 224 - 250 mm	10,40	A
3410247	Spiralo zadelstuk 90° Ø 160 mm buis Ø 280 - 315 mm	10,40	A
3410281	Spiralo zadelstuk 45° Ø 100 mm buis Ø 160 mm	19,80	A
3410282	Spiralo zadelstuk 45° Ø 125 mm buis Ø 160 mm	21,30	A
3410283	Spiralo zadelstuk 45° Ø 160 mm buis Ø 160 mm	22,70	A
3410337	Spiralo boordring Ø 160 mm H=65 mm	5,90	A
3410467	Spiralo kort verloopstuk Ø 160 - Ø 80 mm	9,60	A
3410468	Spiralo kort verloopstuk Ø 160 - Ø 100 mm	9,60	A
3410469	Spiralo kort verloopstuk Ø 160 - Ø 125 mm	9,60	A
3410470	Spiralo kort verloopstuk Ø 160 - Ø 150 mm	10,90	A
3410608	Spiralo buisdeksel Ø 160 mm	4,10	A
3410663	Spiralo deflectorkap Ø 160 mm	262,10	A
3410705	Spiralo regelklep Ø 160 mm	29,20	A
3414608	Spiralo verzinkte beugel Ø 160 mm	4,60	A



Spiralo SAFE
Ø 160 mm
Luchtkanalen



3410542S	Spiralo SAFE verbindingsstuk tbv buis Ø 160 mm	7,30	A
3410024S	Spiralo SAFE gladde bocht 30° Ø 160 mm	21,30	A
3410025S	Spiralo SAFE gladde bocht 45° Ø 160 mm	19,10	A
3410027S	Spiralo SAFE gladde bocht 90° Ø 160 mm	24,10	A
3410112S	Spiralo SAFE T-stuk 90° Ø 160 mm	50,90	A
3410337S	Spiralo SAFE boordring Ø 160 mm H=65 mm	8,60	A
3410467S	Spiralo SAFE verloopstuk hulpst./buis Ø 160 - Ø 80 mm	12,30	A
3410468S	Spiralo SAFE verloopstuk hulpst./buis Ø 160 - Ø 100 mm	12,30	A
3410469S	Spiralo SAFE verloopstuk hulpst./buis Ø 160 - Ø 125 mm	12,60	A
3410470S	Spiralo SAFE verloopstuk hulpst./buis Ø 160 - Ø 150 mm	13,30	A
3410705S	Spiralo SAFE regelklep Ø 160 mm	38,50	A

* Overige Spiralo Safe materialen Ø 160 mm op aanvraag



R-VENT[®] Producten

voor ventilatie- en luchtbehandeling

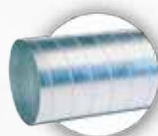

R-Vent Buizen



R-Vent Instortsystemen



R-Vent Safe, hulpstukken



R-Vent Flex, flexibele slangen



R-Vent Ventielen en Roosters



R-Vent Brandwerende producten



R-Vent Geluiddempers



R-Vent Renovatiemateriaal



R-Vent Bevestigings- en Montagemateriaal



R-Vent Luchtbehandelingskasten en Woonhuisventilatoren

R-Vent is een merk van R-Vent Group, de ventilatie- en luchtdivisie van Bergschenhoek Groep. R-Vent producten en systemen zijn kwalitatief hoogwaardige oplossingen voor een comfortabel binnenklimaat met garantie ten aanzien van luchtdichtheid, energie, geluid en comfort. Toepassingsgebieden zijn onder andere woningen, woon- en utiliteitsgebouwen (o.a. kantoren, kinderdagverblijven & scholen).

Kijk voor een volledig overzicht van alle R-Vent Producten in de R-Vent Snelselectie. Nog geen Snelselectie? Vraag ernaar bij uw vestiging.

R-Vent Group B.V., Boterdorpseweg 10, 2661 AC, Bergschenhoek - www.r-vent.com



VENTILATIEKANALEN

Spiralo Ventilatiekanalen Gegalvaniseerd

Spiralo
Ø 180 mm
Luchtkanalen



Artikelnr.	Omschrijving	Brutoprijs	Krt.G
3401140	Spiralo buis sendz. Ø 180 mm L=3000 mm	52,40	A
3410543	Spiralo verbindingsstuk tbv buis Ø 180 mm	4,00	A
3410568	Spiralo verbindingsstuk tbv hulpstuk Ø 180 mm	4,00	A
3410029	Spiralo gladde bocht 30° Ø 180 mm	19,80	A
3410030	Spiralo gladde bocht 45° Ø 180 mm	17,70	A
3410031	Spiralo gladde bocht 90° Ø 180 mm	25,30	A
3413130	Spiralo plooi-bocht 45° Ø 180 mm	17,50	A
3413060	Spiralo plooi-bocht 90° Ø 180 mm	17,50	A
3410117	Spiralo geperst T-stuk 90° Ø180 mm	36,00	A
3410113	Spiralo T-stuk 90° Ø 180 spruit Ø 100 mm	24,60	A
3410114	Spiralo T-stuk 90° Ø 180 spruit Ø 125 mm	28,50	A
3410115	Spiralo T-stuk 90° Ø 180 spruit Ø 150 mm	31,80	A
3410116	Spiralo T-stuk 90° Ø 180 spruit Ø 160 mm	34,60	A
3410233	Spiralo zadelstuk 90° Ø 180 mm buis Ø 200 mm	13,30	A
3410240	Spiralo zadelstuk 90° Ø 180 mm buis Ø 224 - 250 mm	13,30	A
3410248	Spiralo zadelstuk 90° Ø 180 mm buis Ø 280 - 355 mm	13,30	A
3410338	Spiralo boordring Ø 180 mm H=65 mm	6,70	A
3410471	Spiralo kort verloopstuk Ø 180 - Ø 100 mm	12,50	A
3410472	Spiralo kort verloopstuk Ø 180 - Ø 125 mm	12,50	A
3410473	Spiralo kort verloopstuk Ø 180 - Ø 150 mm	12,50	A
3410474	Spiralo kort verloopstuk Ø 180 - Ø 160 mm	12,50	A
3410479	Spiralo kort verloopstuk Ø 200 - Ø 180 mm	14,40	A
3410487	Spiralo kort verloopstuk Ø 250 - Ø 180 mm	19,20	A
3410609	Spiralo buisdeksel Ø 180 mm	6,10	A
3410664	Spiralo deflectorkap Ø 180 mm	283,80	A
3410706	Spiralo regelklep Ø 180 mm	32,60	A
3414609	Spiralo verzinkte beugel Ø 180 mm	5,50	A

Spiralo SAFE
Ø 180 mm
Luchtkanalen



3410543S	Spiralo SAFE verbindingsstuk tbv buis Ø 180 mm	11,00	A
3410029S	Spiralo SAFE gladde bocht 30° Ø 180 mm	26,00	A
3410030S	Spiralo SAFE gladde bocht 45° Ø 180 mm	24,20	A
3410031S	Spiralo SAFE gladde bocht 90° Ø 180 mm	31,50	A
3410117S	Spiralo SAFE T-stuk 90° Ø 180 mm	60,70	A
3410338S	Spiralo SAFE boordring Ø 180 mm H=65 mm	10,10	A
3410471S	Spiralo SAFE verloopstuk hulpst./buis Ø 180 - Ø 100 mm	14,10	A
3410472S	Spiralo SAFE verloopstuk hulpst./buis Ø 180 - Ø 125 mm	14,30	A
3410473S	Spiralo SAFE verloopstuk hulpst./buis Ø 180 - Ø 150 mm	14,60	A
3410474S	Spiralo SAFE verloopstuk hulpst./buis Ø 180 - Ø 160 mm	15,10	A
3410706S	Spiralo SAFE regelklep Ø 180 mm	46,10	A

* Overige Spiralo Safe materialen Ø 180 mm op aanvraag



VENTILATIEKANALEN

Spiralo Ventilatiekanalen Gegalvaniseerd

Spiralo
 Ø 200 mm
 Luchtkanalen



Artikelnr.	Omschrijving	Brutoprijs	Krt.G
3401160	Spiralo buis sendz. Ø 200 mm L=3000 mm	55,50	A
3410544	Spiralo verbindingsstuk tbv buis Ø 200 mm	4,00	A
3410569	Spiralo verbindingsstuk tbv hulpstuk Ø 200 mm	4,00	A
3410033	Spiralo gladde bocht 30° Ø 200 mm	22,00	A
3410034	Spiralo gladde bocht 45° Ø 200 mm	19,10	A
3410036	Spiralo gladde bocht 90° Ø 200 mm	27,90	A
3413140	Spiralo plooi bocht 45° Ø 200 mm	17,50	A
3413070	Spiralo plooi bocht 90° Ø 200 mm	17,50	A
3410122	Spiralo geperst T-stuk 90° Ø 200 mm	39,20	A
3410118	Spiralo T-stuk 90° Ø 200 spruit Ø 100 mm	24,10	A
3410119	Spiralo T-stuk 90° Ø 200 spruit Ø 125 mm	26,70	A
3410120	Spiralo T-stuk 90° Ø 200 spruit Ø 150 mm	31,80	A
3410121	Spiralo T-stuk 90° Ø 200 spruit Ø 160 mm	33,30	A
3410210	Spiralo T-stuk 45° Ø 200 mm	79,40	A
3410228	Spiralo zadelstuk 90° Ø 80 mm buis Ø 180 - 200 mm	6,60	A
3410229	Spiralo zadelstuk 90° Ø 100 mm buis Ø 180 - 200 mm	6,30	A
3410230	Spiralo zadelstuk 90° Ø 125 mm buis Ø 180 - 200 mm	7,70	A
3410231	Spiralo zadelstuk 90° Ø 150 mm buis Ø 180 - 200 mm	10,70	A
3410232	Spiralo zadelstuk 90° Ø 160 mm buis Ø 180 - 200 mm	10,70	A
3410233	Spiralo zadelstuk 90° Ø 180 mm buis Ø 200 mm	13,30	A
3410234	Spiralo zadelstuk 90° Ø 200 mm buis Ø 200 mm	13,60	A
3410241	Spiralo zadelstuk 90° Ø 200 mm buis Ø 224 - 250 mm	13,60	A
3410249	Spiralo zadelstuk 90° Ø 200 mm buis Ø 280 - 315 mm	13,60	A
3410284	Spiralo zadelstuk 45° Ø 100 mm buis Ø 200 mm	19,80	A
3410285	Spiralo zadelstuk 45° Ø 125 mm buis Ø 200 mm	21,30	A
3410286	Spiralo zadelstuk 45° Ø 150 mm buis Ø 200 mm	22,60	A
3410287	Spiralo zadelstuk 45° Ø 160 mm buis Ø 200 mm	22,60	A
3410288	Spiralo zadelstuk 45° Ø 200 mm buis Ø 200 mm	32,30	A
3410339	Spiralo boordring Ø 200 mm H = 65 mm	6,50	A
3410475	Spiralo kort verloopstuk Ø 200 - Ø 100 mm	16,60	A
3410476	Spiralo kort verloopstuk Ø 200 - Ø 125 mm	14,60	A
3410477	Spiralo kort verloopstuk Ø 200 - Ø 150 mm	14,00	A
3410478	Spiralo kort verloopstuk Ø 200 - Ø 160 mm	12,70	A
3410479	Spiralo kort verloopstuk Ø 200 - Ø 180 mm	14,50	A
3410488	Spiralo kort verloopstuk Ø 250 - Ø 200 mm	15,90	A
3410490	Spiralo kort verloopstuk Ø 300 - Ø 200 mm	19,70	A
3410493	Spiralo kort verloopstuk Ø 315 - Ø 200 mm	20,60	A
3410610	Spiralo buisdeksel Ø 200 mm	6,20	A
3410665	Spiralo deflectorkap Ø 200 mm	269,10	A
3410707	Spiralo regelklep Ø 200 mm	32,60	A
3414610	Spiralo verzinkte beugel Ø 200 mm	5,70	A



Spiralo SAFE
 Ø 200 mm
 Luchtkanalen



3410544S	Spiralo SAFE verbindingsstuk tbv buis Ø 200 mm	11,10	A
3410033S	Spiralo SAFE gladde bocht 30° Ø 200 mm	28,30	A
3410034S	Spiralo SAFE gladde bocht 45° Ø 200 mm	25,30	A
3410036S	Spiralo SAFE gladde bocht 90° Ø 200 mm	34,00	A
3410122S	Spiralo SAFE T-stuk 90° Ø 200 mm	60,90	A
3410339S	Spiralo SAFE boordring Ø 200 mm H=65 mm	9,90	A
3410707S	Spiralo SAFE regelklep Ø 200 mm	46,10	A

* Overige Spiralo Safe materialen Ø 200 mm op aanvraag

VENTILATIEKANALEN

Spiralo Ventilatiekanalen Gegalvaniseerd

Spiralo
 Ø 250 mm
 Luchtkanalen



Artikelnr.	Omschrijving	Brutoprijs	Krt.G
3401200	Spiralo buis sendz. Ø 250 mm L=3000 mm	70,10	A
3410546	Spiralo verbindingsstuk tbv buis Ø 250 mm	4,80	A
3410571	Spiralo verbindingsstuk tbv hulpstuk Ø 250 mm	4,80	A
3410043	Spiralo gladde bocht Ø 250 mm 30°	28,80	A
3410044	Spiralo gladde bocht Ø 250 mm 45°	27,20	A
3410045	Spiralo gladde bocht Ø 250 mm 90°	42,60	A
3410133	Spiralo geperst T-stuk 90° Ø 250	49,60	A
3410127	Spiralo T-stuk 90° Ø 250 spruit Ø 100 mm	28,30	A
3410128	Spiralo T-stuk 90° Ø 250 spruit Ø 125 mm	28,30	A
3410129	Spiralo T-stuk 90° Ø 250 spruit Ø 150 mm	33,40	A
3410130	Spiralo T-stuk 90° Ø 250 spruit Ø 160 mm	33,70	A
3410131	Spiralo T-stuk 90° Ø 250 spruit Ø 180 mm	45,90	A
3410132	Spiralo T-stuk 90° Ø 250 spruit Ø 200 mm	41,90	A
3410212	Spiralo T-stuk 45° Ø 250 mm	113,50	A
3410236	Spiralo zadelstuk 90° Ø 100 mm buis Ø 224 - 250 mm	6,30	A
3410237	Spiralo zadelstuk 90° Ø 125 mm buis Ø 224 - 250 mm	7,70	A
3410238	Spiralo zadelstuk 90° Ø 150 mm buis Ø 224 - 250 mm	10,80	A
3410239	Spiralo zadelstuk 90° Ø 160 mm buis Ø 224 - 250 mm	10,80	A
3410240	Spiralo zadelstuk 90° Ø 180 mm buis Ø 224 - 250 mm	13,30	A
3410241	Spiralo zadelstuk 90° Ø 200 mm buis Ø 224 - 250 mm	13,60	A
3410243	Spiralo zadelstuk 90° Ø 250 mm buis Ø 250 mm	18,80	A
3410289	Spiralo zadelstuk 45° Ø 100 mm buis Ø 250 mm	19,80	A
3410290	Spiralo zadelstuk 45° Ø 125 mm buis Ø 250 mm	21,30	A
3410291	Spiralo zadelstuk 45° Ø 150 mm buis Ø 250 mm	22,60	A
3410292	Spiralo zadelstuk 45° Ø 160 mm buis Ø 250 mm	22,60	A
3410293	Spiralo zadelstuk 45° Ø 200 mm buis Ø 250 mm	32,30	A
3410294	Spiralo zadelstuk 45° Ø 250 mm buis Ø 250 mm	42,70	A
3410341	Spiralo boordring Ø 250 mm H = 65 mm	8,10	A
3410484	Spiralo kort verloopstuk Ø 250 - Ø 125 mm	19,90	A
3410485	Spiralo kort verloopstuk Ø 250 - Ø 150 mm	19,20	A
3410486	Spiralo kort verloopstuk Ø 250 - Ø 160 mm	19,20	A
3410487	Spiralo kort verloopstuk Ø 250 - Ø 180 mm	19,20	A
3410488	Spiralo kort verloopstuk Ø 250 - Ø 200 mm	15,90	A
3410489	Spiralo kort verloopstuk Ø 250 - Ø 225 mm	18,10	A
3410612	Spiralo buisdeksel Ø 250 mm	7,40	A
3410666	Spiralo deflectorkap Ø 250 mm	276,00	A
3410709	Spiralo regelklep Ø 250 mm	35,60	A
3414612	Spiralo verzinkte beugel Ø 250 mm	7,10	A

* Spiralo Safe materialen Ø 250 mm op aanvraag

Spiralo
 Ø 300 mm
 Luchtkanalen



3401240	Spiralo buis sendz. Ø 300 mm L=3000 mm	98,00	A
3410548	Spiralo verbindingsstuk tbv buis Ø 300 mm	7,40	A
3410573	Spiralo verbindingsstuk tbv hulpstuk Ø 300 mm	7,40	A
3410051	Spiralo segmentbocht 30° Ø 300 mm	34,60	A
3410052	Spiralo segmentbocht 45° Ø 300 mm	35,70	A
3410053	Spiralo segmentbocht 90° Ø 300 mm	51,10	A
3410141	Spiralo geperst T-stuk 90° Ø 300 mm	65,30	A
3410138	Spiralo T-stuk 90° Ø 300 mm spruit Ø 125 mm	34,40	A
3410139	Spiralo T-stuk 90° Ø 300 mm spruit Ø 200 mm	45,10	A
3410140	Spiralo T-stuk 90° Ø 300 mm spruit Ø 250 mm	51,50	A
3410213	Spiralo T-stuk 45° Ø 300 mm	145,40	A
3410244	Spiralo zadelstuk 90° Ø 100 mm buis Ø 280 - 355 mm	6,30	A
3410245	Spiralo zadelstuk 90° Ø 125 mm buis Ø 280 - 355 mm	7,70	A

VENTILATIEKANALEN

Spiralo Ventilatiekanalen Gegalvaniseerd

Spiralo
 Ø 300 mm
 Vervolg



Artikelnr.	Omschrijving	Brutoprijs	Krt.G
3410246	Spiralo zadelstuk 90° Ø 150 mm buis Ø 280 - 355 mm	10,80	A
3410248	Spiralo zadelstuk 90° Ø 180 mm buis Ø 280 - 355 mm	13,30	A
3410343	Spiralo boordring Ø 300 mm H = 65 mm	11,90	A
3410490	Spiralo kort verloopstuk Ø 300 - Ø 200 mm	19,70	A
3410491	Spiralo kort verloopstuk Ø 300 - Ø 250 mm	21,60	A
3410614	Spiralo buisdeksel Ø 300 mm	10,90	A
3410667	Spiralo deflectorcap Ø 300 mm	312,30	A
3410711	Spiralo regelklep Ø 300 mm	49,80	A
3414614	Spiralo verzinkte beugel Ø 300 mm	8,50	A

Spiralo
 Ø 315 mm
 Luchtkanalen



3401260	Spiralo buis sendz. Ø 315 mm L=3000 mm	105,60	A
3410549	Spiralo verbindingsstuk tbv buis Ø 315 mm	6,60	A
3410574	Spiralo verbindingsstuk tbv hulpstuk Ø 315 mm	6,60	A
3410055	Spiralo segmentbocht 30° Ø 315 mm	39,20	A
3410056	Spiralo segmentbocht 45° Ø 315 mm	39,70	A
3410058	Spiralo segmentbocht 90° Ø 315 mm	57,10	A
3410147	Spiralo geperst T-stuk 90° Ø 315 mm	62,70	A
3410142	Spiralo T-stuk 90° Ø 315 spruit Ø 100 mm	34,40	A
3410143	Spiralo T-stuk 90° Ø 315 spruit Ø 125 mm	34,40	A
3410144	Spiralo T-stuk 90° Ø 315 spruit Ø 160 mm	37,40	A
3410145	Spiralo T-stuk 90° Ø 315 spruit Ø 200 mm	45,10	A
3410146	Spiralo T-stuk 90° Ø 315 spruit Ø 250 mm	51,50	A
3410253	Spiralo zadelstuk 90° Ø 315 mm buis Ø 315 mm	25,10	A
3410244	Spiralo zadelstuk 90° Ø 100 mm buis Ø 280 - 355 mm	6,30	A
3410245	Spiralo zadelstuk 90° Ø 125 mm buis Ø 280 - 355 mm	7,70	A
3410246	Spiralo zadelstuk 90° Ø 150 mm buis Ø 280 - 355 mm	10,80	A
3410248	Spiralo zadelstuk 90° Ø 180 mm buis Ø 280 - 355 mm	13,30	A
3410252	Spiralo zadelstuk 90° Ø 300 mm buis Ø 315 mm	26,70	A
3410295	Spiralo zadelstuk 45° Ø 100 mm buis Ø 315 mm	19,80	A
3410296	Spiralo zadelstuk 45° Ø 125 mm buis Ø 315 mm	21,30	A
3410297	Spiralo zadelstuk 45° Ø 150 mm buis Ø 315 mm	22,70	A
3410298	Spiralo zadelstuk 45° Ø 160 mm buis Ø 315 mm	22,70	A
3410299	Spiralo zadelstuk 45° Ø 200 mm buis Ø 315 mm	32,30	A
3410300	Spiralo zadelstuk 45° Ø 250 mm buis Ø 315 mm	42,70	A
3410301	Spiralo zadelstuk 45° Ø 315 mm buis Ø 315 mm	51,40	A
3410344	Spiralo boordring Ø 315 mm H=65 mm	10,30	A
3410492	Spiralo kort verloopstuk Ø 315 - Ø 160 mm	20,60	A
3410493	Spiralo kort verloopstuk Ø 315 - Ø 200 mm	20,60	A
3410494	Spiralo kort verloopstuk Ø 315 - Ø 250 mm	20,60	A
3410503	Spiralo kort verloopstuk Ø 315 - Ø 300 mm	31,60	A
3410504	Spiralo kort verloopstuk Ø 315 - Ø 355 mm	53,20	A
3410615	Spiralo buisdeksel Ø 315 mm	11,90	A
3410668	Spiralo deflectorcap Ø 315 mm	348,60	A
3410712	Spiralo regelklep Ø 315 mm	43,00	A
3414615	Spiralo verzinkte beugel Ø 315 mm	9,10	A

* Spiralo Safe Ø 300 mm en 315 mm kanalen op aanvraag

VENTILATIEKANALEN

Spiralo Ventilatiekanalen Gegalvaniseerd

Spiralo
Ø 355 mm
Luchtkanalen



Artikelnr.	Omschrijving	Brutoprijs	Krt.G
3401280	Spiralo buis sendz. Ø 355 mm L=3000 mm	118,50	A
3410550	Spiralo verbindingsstuk tbv buis Ø 355 mm	7,50	A
3410575	Spiralo verbindingsstuk tbv hulpstuk Ø 355 mm	7,50	A
3410060	Spiralo segmentbocht 30° Ø 355 mm	52,60	A
3410061	Spiralo segmentbocht 45° Ø 355 mm	52,50	A
3410062	Spiralo segmentbocht 90° Ø 355 mm	69,20	A
3410148	Spiralo T-stuk 90° Ø 355 mm spruit Ø 160 mm	55,80	A
3410149	Spiralo T-stuk 90° Ø 355 mm spruit Ø 200 mm	55,90	A
3410150	Spiralo T-stuk 90° Ø 355 mm spruit Ø 250 mm	56,60	A
3410345	Spiralo boordring Ø 355 mm H = 65 mm	11,90	A
3410500	Spiralo kort verloopstuk Ø 355 - Ø 250 mm	34,10	A
3410616	Spiralo buisdeksel Ø 355 mm	13,70	A
3410669	Spiralo deflectorkap Ø 355 mm	376,80	A
3410713	Spiralo regelklep Ø 355 mm	53,10	A
3414616	Spiralo verzinkte beugel Ø 355 mm	10,10	A

Spiralo
Ø 400 mm
Luchtkanalen



3401300	Spiralo buis sendz. Ø 400 mm L=3000 mm	139,20	A
3410551	Spiralo verbindingsstuk tbv buis Ø 400 mm	9,50	A
3410576	Spiralo verbindingsstuk tbv hulpstuk Ø 400 mm	9,50	A
3410064	Spiralo segmentbocht 30° Ø 400 mm	59,20	A
3410065	Spiralo segmentbocht 45° Ø 400 mm	59,80	A
3410067	Spiralo segmentbocht 90° Ø 400 mm	90,10	A
3410151	Spiralo T-stuk 90° Ø 400 spruit Ø 200 mm	58,50	A
3410152	Spiralo T-stuk 90° Ø 400 spruit Ø 250 mm	64,90	A
3410153	Spiralo T-stuk 90° Ø 400 spruit Ø 315 mm	65,60	A
3410154	Spiralo geperst T-stuk 90° Ø 400 mm	87,60	A
3410346	Spiralo boordring Ø 400 mm H=80 mm	13,20	A
3410495	Spiralo kort verloopstuk Ø 400 - Ø 200 mm	50,50	A
3410617	Spiralo buisdeksel Ø 400 mm	17,00	A
3410670	Spiralo deflectorkap Ø 400 mm	520,90	A
3410714	Spiralo regelklep Ø 400 mm	67,30	A
3414617	Spiralo verzinkte beugel Ø 400 mm	10,20	A

Spiralo
Ø 450 mm
Luchtkanalen



3401320	Spiralo buis sendz. Ø 450 mm L=3000 mm	169,20	A
3410552	Spiralo verbindingsstuk tbv buis Ø 450 mm	10,70	A
3410577	Spiralo verbindingsstuk tbv hulpstuk Ø 450 mm	10,70	A
3410069	Spiralo segmentbocht 30° Ø 450 mm	63,20	A
3410070	Spiralo segmentbocht 45° Ø 450 mm	66,60	A
3410071	Spiralo segmentbocht 90° Ø 450 mm	95,10	A
3410347	Spiralo boordring Ø 450 mm H = 80 mm	16,00	A
3410618	Spiralo buisdeksel Ø 450 mm	19,80	A
3410671	Spiralo deflectorkap Ø 450 mm	615,10	A
3410715	Spiralo regelklep Ø 450 mm	83,50	A
3414618	Spiralo verzinkte beugel Ø 450 mm	13,60	A

* Spiralo Safe kanalen op aanvraag

VENTILATIEKANALEN

Ventilatietkanalen Kunststof

Spiralo
 Ø 500 mm
 Luchtkanalen



Artikelnr.	Omschrijving	Brutoprijs	Krt.G
3401340	Spiralo buis sendz. Ø 500 mm L=3000 mm	182,90	A
3410553	Spiralo verbindingsstuk tbv buis Ø 500 mm	13,30	A
3410578	Spiralo verbindingsstuk tbv hulpstuk Ø 500 mm	13,30	A
3410073	Spiralo segmentbocht 30° Ø 500 mm	63,00	A
3410074	Spiralo segmentbocht 45° Ø 500 mm	72,40	A
3410075	Spiralo segmentbocht 90° Ø 500 mm	105,90	A
3410348	Spiralo boordring Ø 500 mm H = 80 mm	16,20	A
3410619	Spiralo buisdeksel Ø 500 mm	21,30	A
3410672	Spiralo deflectorkap Ø 500 mm	724,00	A
3410716	Spiralo regelklep Ø 500 mm	99,90	A
3414619	Spiralo verzinkte beugel Ø 500 mm	13,80	A

Spiralo
 Ø 560 mm
 Luchtkanalen



3401360	Spiralo buis sendz. Ø 560 mm L=3000 mm	269,00	A
3410554	Spiralo verbindingsstuk tbv buis Ø 560 mm	15,90	A
3410579	Spiralo verbindingsstuk tbv hulpstuk Ø 560 mm	15,90	A
3410077	Spiralo segmentbocht 30° Ø 560 mm	77,30	A
3410078	Spiralo segmentbocht 45° Ø 560 mm	89,60	A
3410079	Spiralo segmentbocht 90° Ø 560 mm	130,70	A
3410349	Spiralo boordring Ø 560 mm H = 80 mm	19,60	A
3410620	Spiralo buisdeksel Ø 560 mm	30,10	A
3410673	Spiralo deflectorkap Ø 560 mm	795,40	A
3410717	Spiralo regelklep Ø 560 mm	112,20	A
3414620	Spiralo verzinkte beugel Ø 560 mm	15,20	A

Spiralo
 Ø 600 mm
 Luchtkanalen



3401380	Spiralo buis sendz. Ø 600mm L=3000 mm	283,10	A
3410555	Spiralo verbindingsstuk tbv buis Ø 600 mm	16,90	A
3410580	Spiralo verbindingsstuk tbv hulpstuk Ø 600 mm	16,90	A
3410081	Spiralo segmentbocht 45° Ø 600 mm	110,00	A
3410082	Spiralo segmentbocht 90° Ø 600 mm	182,90	A
3410350	Spiralo boordring Ø 600 mm H = 80 mm	22,80	A
3410621	Spiralo buisdeksel Ø 600 mm	32,60	A
3414621	Spiralo verzinkte beugel Ø 600 mm	17,30	A

Spiralo
 Ø 630 mm
 Luchtkanalen



3401400	Spiralo buis sendz. Ø 630 mm L=3000 mm	296,30	A
3410556	Spiralo verbindingsstuk tbv buis Ø 630 mm	19,80	A
3410581	Spiralo verbindingsstuk tbv hulpstuk Ø 630 mm	19,80	A
3410084	Spiralo segmentbocht 30° Ø 630 mm	115,90	A
3410085	Spiralo segmentbocht 45° Ø 630 mm	115,90	A
3410086	Spiralo segmentbocht 90° Ø 630 mm	168,00	A
3410351	Spiralo boordring Ø 630 mm H = 80 mm	20,30	A
3410622	Spiralo buisdeksel Ø 630 mm	34,70	A
3410674	Spiralo deflectorkap Ø 630 mm	1041,70	A
3410718	Spiralo regelklep Ø 630 mm	126,40	A
3414622	Spiralo verzinkte beugel Ø 630 mm	19,40	A

* Spiralo Safe kanalen op aanvraag



VENTILATIEKANALEN

Ventilatiekanalen Kunststof

**Kunststof
Kanaal
110 x 54 mm**



Artikelnr.	Omschrijving	Brutoprijs	Krt.G
3520010	Buis L=100 mm 110 x 54 mm	2,60	A
3520020	Buis L=330 mm 110 x 54 mm	4,40	A
3520030	Buis L=500 mm 110 x 54 mm	5,70	A
3520000	Buis L=1000 mm 110 x 54 mm	8,70	A
3520040	Buis L=1500 mm 110 x 54 mm	15,50	A
3520050	Eindkap 110 x 54 mm	6,10	A
3520060	Buisverbinder 110 x 54 mm	3,10	A
3520070	Buisverbinder met terugslagklep 110 x 54 mm	4,90	A
3520080	Overgangsstuk Haaks Ø 100mm - 110 x 54 mm inw.	7,90	A
3520090	Overgangsstuk Haaks Ø 100mm - 110 x 54 mm uitw.	8,00	A
3520100	Variabel hoekstuk 110 x 54 mm	7,80	A
3520110	Hoekstuk 110 x 54 mm Horizontaal 90°	8,00	A
3520120	Hoekstuk 150 x 70 mm Horizontaal 90°	17,60	A
3520130	Hoekstuk 110 x 54 mm Vertikaal 90°	7,60	A
3520140	Overgangsstuk Recht Ø 100 mm - 110 x 54 mm	8,00	A
3520150	Overgangsstuk Recht Ø 100 mm - 110 x 54 mm Kort	5,80	A
3520160	Verloop 110 x 54 mm - 204 x 60 mm	4,90	A
3520170	T-stuk 110 x 54 - 100 mm	10,60	A
3520180	Buisverbinder 110 x 54 - 100 mm terugslagklep	8,50	A
3520190	Bevestigingsbeugel 110 x 54 mm	1,80	A
3520200	T-stuk 110 x 54 mm horizontaal 90°	10,60	A
3520210	Bochtstuk Ø 100 mm 110 x 54 mm L = 300-500 mm	20,90	A

**Kunststof
Kanaal
204 x 60 mm**



3520310	Buis L=1000 mm 204 x 60 mm	17,80	A
3520320	Buis L=1500 mm 204 x 60 mm	26,20	A
3520330	Eindkap 204 x 60 mm	9,10	A
3520340	Buisverbinder 204 x 60 mm	11,50	A
3520350	Buisverbinder 204 x 60 mm met terugslagklep	13,40	A
3520300	Overgangsstuk haaks Ø 100 - 204 x 60 mm	15,00	A
3520360	Overgangsstuk haaks Ø 125 - 204 x 60 mm inw.	15,00	A
3520380	Verloopring Ø 100 - 125 mm	4,30	A
3520390	Hoekstuk 204 x 60 mm horizontaal 45°	20,00	A
3520400	Hoekstuk 204 x 60 mm horizontaal 90°	22,40	A
3520410	Hoekstuk 204 x 60 mm vertikaal 90°	18,90	A
3520420	Overgangsstuk recht Ø 125 - 204 x 60 mm	15,60	A
3520430	T-stuk 204 x 60 mm horizontaal 90°	31,20	A
3520440	Overgangsstuk haaks Ø 150 - 204 x 60 mm	15,00	A
3520800	Bevestigingsbeugel 204 x 60 mm	5,60	A

**Kunststof
Kanaal
220 x 90 mm**

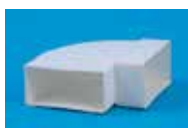

3520450	Buis L=1000 mm 220 x 90 mm	37,30	A
3520460	Buis L=1500 mm 220 x 90 mm	42,80	A
3520470	Buisverbinder 220 x 90 mm	12,80	A
3520480	Bevestigingsbeugel 220 x 90 mm	5,80	A
3520490	Overgangsstuk haaks Ø 150 - 220 x 90 mm	33,80	A
3520500	Hoekstuk 220 x 90 mm horizontaal 90°	46,00	A
3520520	Hoekstuk 220 x 90 mm vertikaal 90°	36,60	A
3520510	Overgangsstuk 204 x 60 mm - 220 x 90 mm	11,80	A
3520530	Overgangsstuk recht Ø 150 - 220 x 90 mm	39,20	A
3520540	Overgangsstuk recht 227 x 133 mm - 220 x 90 mm	15,20	A
3520550	T-stuk 220 x 90 mm horizontaal 90°	33,70	A

VENTILATIEKANALEN

Ventilatiekanalen Kunststof

Kunststof
Eco + Kanaal
169 x 77 mm



Artikelnr.	Omschrijving	Brutoprijs	Krt.G
3521210	Eco + buis L=1000 mm 169 x 77 mm	27,40	A
3521220	Eco + buisverbinder 169 x 77 mm	10,10	A
3521230	Eco + bevestigingsbeugel 169 x 77 mm	8,40	A
3521240	Eco + overgangsstuk haaks Ø 125 - 169 x 77 mm	22,40	A
3521250	Eco + hoekstuk 169 x 77 mm horizontaal 15°	17,70	A
3521260	Eco + hoekstuk 169 x 77 mm horizontaal 90°	26,60	A
3521280	Eco + overgangsstuk recht Ø 125 - 169 x 77 mm	23,10	A
3521290	Eco + bocht Ø 125 mm 90°	26,60	A
3521300	Eco + buis L=1000 mm Ø 150 mm	38,50	A

Kunststof
Eco + Kanaal
220 x 90 mm



3521100	Eco + buis L=1000 mm 220 x 90 mm	47,80	A
3521110	Eco + buisverbinder 220 x 90 mm	14,40	A
3521120	Eco + bevestigingsbeugel 222 x 89 mm	8,40	A
3521130	Eco + overgangsstuk haaks Ø 150 - 220 x 90 mm	39,20	A
3521140	Eco + hoekstuk 220 x 90 mm horizontaal 15°	20,60	A
3521150	Eco + hoekstuk 220 x 90 mm horizontaal 90°	41,90	A
3521160	Eco + hoekstuk 220 x 90 mm vertikaal 90°	39,20	A
3521170	Eco + overgangsstuk recht Ø 150 mm - 220 x 90 mm	33,50	A
3521180	Eco + bocht Ø 150 mm 90°	39,10	A
3521190	Eco + buis L=1000 mm Ø 150 mm	38,50	A
3521200	Eco + buisverbinder Ø 150 mm	12,90	A

RVS
Buitenrooster



3521400	RVS buitenrooster Eco+ 180 mm vaste lamellen	188,70	A
3521410	RVS buitenrooster Eco+ 200 mm vaste lamellen	196,80	A
3521420	RVS buitenrooster Eco+ 169 x 77 mm vaste lamel	157,30	A
3521430	RVS buitenrooster Eco+ 125 mm vaste lamellen	142,70	A
3521440	RVS buitenrooster Eco+ 150 mm vaste lamellen	145,40	A
3521450	RVS buitenrooster Eco+ Ø125 mm gebogen kap	237,10	A
3521460	RVS buitenrooster Eco+ 222 x 89 mm vaste lamel	164,80	A
3521470	RVS buitenrooster Eco+ Ø 150 mm gebogen kap	241,20	A
3521480	Eco star muurdoorvoerunit Ø 125 mm	400,90	A
3521490	Eco star muurdoorvoerunit Ø 150 mm	400,90	A



VENTILATIEKANALEN

Ventilatiekanalen Kunststof

Kunststof
 Ø 100 mm



Artikelnr.	Omschrijving	Brutoprijs	Krt.G
3520600	Telescopische buis Ø 100 mm L = 300-500 mm	13,00	A
3520610	Telescopische buis Ø 100 mm L = 180-300 mm	10,00	A
3520620	Buis L = 350 mm Ø 100 mm	5,40	A
3520630	Buis L = 500 mm Ø 100 mm	7,80	A
3520640	Buis L = 1000 mm Ø 100 mm	14,50	A
3520650	Buis L = 5000 mm Ø 100 mm	45,10	A
3520660	Buisverbinder glad Ø 100 mm	4,20	A
3520670	Bocht Ø 100 mm 90°	10,60	A
3520680	Bocht Ø 100 mm 45°	9,70	A
3520690	T-stuk Ø 100 mm 90°	21,80	A
3520700	Vlinderklep Ø 100 mm (2 klepjes)	9,30	A
3520710	Buisverbinder Ø 100 mm met klep en plaat	5,80	A
3520720	Buisverbinder Ø 100 mm met terugslagklep	10,60	A
3520740	Bevestigingsbeugel Ø 100 mm	3,20	A
3520750	Condenswatervanger Ø 100 - 110 mm	22,10	A
3520760	Overgangstuk recht Ø 100 - 225 x 25 mm	18,50	A

Kunststof
 Ø 125 mm



3520810	Telescopische buis Ø 125 mm L = 300-550 mm	18,90	A
3520820	Telescopische buis Ø 125 mm L = 180-300 mm	13,10	A
3520830	Buis L = 350 mm Ø 125 mm	10,50	A
3520840	Buis L = 500 mm Ø 125 mm	14,10	A
3520850	Buis L = 1000 mm Ø 125 mm	23,70	A
3520860	Buis L = 5000 mm Ø 125 mm	59,90	A
3520870	Buisverbinder met vlinderklep Ø 125 mm	20,00	A
3520880	Vlinderklep Ø 125 mm Gegalvaniseerd	26,30	A
3520890	Brandwerende vlinderklep Ø 125 mm	60,50	A
3520900	Vlinderklep Ø 125 mm (2 klepjes)	11,50	A
3520910	Bocht Ø 125 mm 90°	16,90	A
3520920	Bocht Ø 125 mm 45°	15,40	A
3520930	T-stuk Ø 125 mm 90°	24,90	A
3520940	Buisverbinder Ø 125 mm	7,20	A
3520950	Buisverbinder Ø 125 mm met terugslagklep	13,00	A
3520970	Bevestigingsbeugel Ø 125 mm	4,00	A

Kunststof
 Ø 150 mm



3521000	Telescopische buis Ø 150 mm L = 300-500 mm	21,90	A
3521010	Telescopische buis Ø 150 mm L = 180-300 mm	16,9	A
3521020	Buis L = 350 mm Ø 150 mm	11,40	A
3521030	Buis L = 500 mm Ø 150 mm	15,70	A
3521040	Buis L = 1000 mm Ø 150 mm	24,80	A
3521050	Buis L = 5000 mm Ø 150 mm	73,00	A
3521060	Buisverbinder Ø 150 mm	10,00	A
3521070	Buisverbinder Ø 150 mm met terugslagklep	14,30	A
3521080	Bocht Ø 150 mm 90°	21,60	A
3521090	Bocht Ø 150 mm 45°	18,60	A



VENTILATIEKANALEN

Ventilatiekanalen Instort Gegalvaniseerd

**Gegalvaniseerd
170/70 mm
Instortkanaal**



Artikelnr.	Omschrijving	Brutoprijs	Krt.G
3420000	Instort 170 / 70 mm buis L = 3000 mm	49,70	A
3420010	Instort 170 / 70 mm bocht 90° Horizontaal	24,00	A
3420015	Instort 170 / 70 mm bocht 90° verticaal	39,80	A
3420016	Instort 170 / 70 mm bocht 90° verticaal ronde rug	33,80	A
3420017	Instort 170 / 70 mm bocht 45° verticaal	31,80	A
3420020	Instort 170 / 70 mm bocht 45° horizontaal	23,90	A
3420030	Instort 170 / 70 mm koppelstuk	5,00	A
3420140	Instort 170 / 70 mm zijaansluiting 170 / 70 mm op 170 / 70 mm	11,40	A
3420040	Instort 170 / 70 mm deksel	4,30	A
3420120	Instort 170 / 70 mm kunststof deksel Ø 125 mm	1,70	A
3420130	Instort 170 / 70 mm kunststof deksel Ø 150 mm	2,20	A
3420050	Instort 170 / 70 mm verloop 170 / 70 mm - Ø 125 mm recht	53,40	A
3420060	Instort 170 / 70 mm lepe hoek Ø 125 mm symetrisch	45,10	A
3420100	Instort 170 / 70 mm lepe hoek Ø 125 mm links	45,10	A
3420110	Instort 170 / 70 mm lepe hoek Ø 125 mm rechts	45,10	A
3420065	Instort 170 / 70 mm lepe hoek Ø 150 mm symetrisch	50,00	A
3420070	Instort 170 / 70 mm T-stuk 90° stromend	35,60	A
3420080	Instortkanaal 170 / 70 mm flensbus Ø 125 mm H=65mm	4,90	A
3420090	Instortkanaal 170 / 70 mm flensbus Ø 125 mm H=80mm	4,90	A

**Gegalvaniseerd
220/80 mm
Instortkanaal**



3420400	Instort 220 / 80 mm buis L = 3000 mm	55,40	A
3420410	Instort 220 / 80 mm bocht 90° Horizontaal	25,50	A
3420415	Instort 220 / 80 mm bocht 90° verticaal	47,60	A
3420417	Instort 220 / 80 mm bocht 45° verticaal	59,80	A
3420420	Instort 220 / 80 mm bocht 45° horizontaal	26,80	A
3420430	Instort 220 / 80 mm koppelstuk	5,80	A
3420540	Instort 220 / 80 mm zijaansluiting 220 / 80 mm op 220 / 80 mm	14,10	A
3420440	Instort 220 / 80 mm deksel	8,50	A
3420120	Instort 220 / 80 mm kunststof deksel Ø 125 mm	1,70	A
3420130	Instort 220 / 80 mm kunststof deksel Ø 150 mm	2,20	A
3420450	Instort 220 / 80 mm verloop 220 / 80 mm - Ø 150 mm recht	56,20	A
3420460	Instort 220 / 80 mm lepe hoek Ø 150 mm symetrisch	74,10	A
3420500	Instort 220 / 80 mm lepe hoek Ø 150 mm links	78,30	A
3420510	Instort 220 / 80 mm lepe hoek Ø 150 mm rechts	78,30	A
3420465	Instort 220 / 80 mm lepe hoek Ø 125 mm symetrisch	73,70	A
3420470	Instort 220 / 80 mm T-stuk 90° stromend	80,40	A
3420480	Instortkanaal 220 / 80 mm flensbus Ø 150 mm H=65mm	5,00	A
3420490	Instortkanaal 220 / 80 mm flensbus Ø 150 mm H=80mm	5,00	A

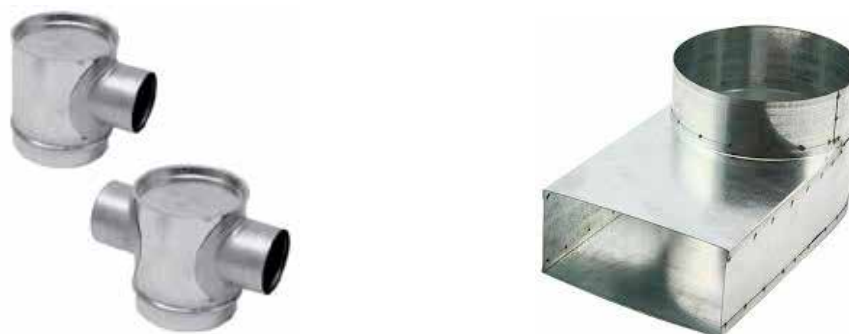

Altijd het beste klimaat voor

EEN COMFORTABEL THUIS

zehnder
always the
best climate

Het merk Zehnder is wereldwijd vertegenwoordigd in 20 landen en levert producten en systemen op het gebied van verwarming, koeling, ventilatie en filtering. Deze producten en systemen dragen bij aan een energiezuinige, comfortabele en gezonde woon- en werkomgeving, ook wel een vitaal binnenklimaat genoemd.

www.zehnder.nl



HOOFDSTUK 11

Woonhuisventilatie / Ventilatiesystemen

Omschrijving	Pagina
Ventilatie doorvoeren - Dakplaten/Loodpan/glijschaal - Rioolontluchting - EPDM Manchet	108
Ventilatie Alu Flex - Terugslagkleppen - Muurdoorvoer - Buitenroosters - Natuurlijke ontluuchting	109
Ventilatioeroosters - Schoepenroosters	110
Ventilatie Bevestigingsmaterialen - Aluminium en PVC Tape - Plaatschroeven	111
Zehnder Comfofan S - Pijp- en Dakventilatoren - Keukenbox - WHR WTW-units 918 / 920	112
WHR WTW-units 930 / ComfoCool Q / ComfoAir Q en E / Comfospot 50 / ComfoAir 70	113
Zehnder MX Dakventilatoren - Accessoires - Schakelaars SAG	114
Zehnder VDX Dakventilatoren - Accessoires - Pasflenzen - Centrifugaal kanaalventilatoren	115
Zehnder Onderdelen Woonhuisventilatie	116
Zehnder Onderdelen Woonhuisventilatie	117
Zehnder Onderdelen Woonhuisventilatie - Ventilatieventielen	118
Toilet / Badkamer ventilatoren	119



** Ook online bestellen? Neem contact op met ons verkoopteam!*

VENTILATIESYSTEMEN

Ventilatie Accessoires

Ventilatie doorvoeren



Artikelnr.	Omschrijving	Brutoprijs	Krt.G
3200011	Ubbink Ventub ventilatiedoorvoer Ø 110 mm	36,50	A
3200010	Ubbink Multivent 5V ventilatiedoorvoer Ø 125 mm	69,90	A
3200050	BUHO PP ventilatiedoorvoer Ø 100 mm L = 960 mm	37,10	A
3200070	BUHO PP Megavent ventilatiedoorvoer Ø 125 mm	71,80	A
3200075	BUHO PP Megavent ventilatiedoorvoer Ø 150 mm	81,60	A
3200102	Geisoleerde ventilatiedoorvoer Ø 125 mm EPS isolatie	112,40	A
3200104	Geisoleerde ventilatiedoorvoer Ø 130 mm EPS isolatie	111,80	A
3200100	Geisoleerde ventilatiedoorvoer Ø 150 mm EPS isolatie	111,80	A
3448400	Geisoleerde ventilatiedoorvoer Ø 160 mm EPS isolatie	113,00	A
3200108	Geisoleerde ventilatiedoorvoer Ø 180 mm EPS isolatie	129,30	A

Dakpannen Glijschalen



3200020	Universele Ubiflex pan met glijschaal 15° - 55°	55,20	A
3200130	Elastipan 500 x 625 mm 1 pans zwart	63,90	A
3200110	Elastipan 800 x 1000 mm 2 pans zwart	130,70	A
5800010	Universele loodpan 80/130 mm 25° - 45°	56,70	A
3200060	Glijschaal universele loodpan Ø 119 mm (vent Ø 110 mm)	11,90	A
5800020	Glijschaal universele loodpan Ø 139 mm (vent Ø 125 mm)	8,20	A
3200049	Glijschaal universele loodpan Ø 159 mm (vent Ø 150 mm)	11,90	A
5800015	Dakpan Sneldek zwart 1 pans kunststof	35,90	A
5800017	Dakpan Neroma zwart 1 pans kunststof	35,90	A

Plakplaten



3200040	BUHO Plakplaat platdak voor ventilatiedoorvoer Ø 100 mm	24,70	A
3200041	BUHO Plakplaat platdak voor ventilatiedoorvoer Ø 125 mm	25,90	A
3200042	BUHO Plakplaat platdak voor ventilatiedoorvoer Ø 150 mm	30,30	A
3200043	BUHO Plakplaat platdak voor ventilatiedoorvoer Ø 180 mm	40,60	A

Riool-ontluchting



3200080	PP Rioolontluchting Ø 110 mm	40,50	A
3200055	Aluminium plakplaat platdak rioolontluchting (119 mm)	25,20	A
5800010	Universele loodpan 80/130 mm 25° - 45°	56,70	A
3200060	Glijschaal universele loodpan Ø119mm	11,90	A
3200130	Elastipan 500 x 625 mm 1 pans zwart	63,90	A

Manchet

5800080	Dampdichte kunststof flexibele manchet	22,00	A
---------	--	-------	---

EPDM Manchet



5800120	EPDM DDV manchet Ø 110 - 200 mm Flexub	119,50	A
5800125	EPDM DDV manchet Ø 150 - 315 mm	177,30	A
5800128	EPDM DDV Slabbe 80-130 mm compleet	134,50	A
5800127	EPDM DDV Slabbe 130-200 mm compleet	131,70	A
5800129	EPDM DDV Slabbe 250-300 mm compleet	145,30	A



VENTILATIESYSTEMEN

Ventilatie Accessoires

	Artikelnr.	Omschrijving	Brutoprijs	Krt.G
Aluminium Flex AF	3448030	Aluminium Flex AF Ø 100 mm L = 3000 mm	13,20	A
	3448010	Aluminium Flex AF Ø 125 mm L = 3000 mm	14,30	A
	3448020	Aluminium Flex AF Ø 150 mm L = 3000 mm	17,10	A
Aluminium Laminaat	3448060	Aluminium Flex Laminaat Ø 100 mm L = 10 meter	40,70	A
	3448070	Aluminium Flex Laminaat Ø 125 mm L = 10 meter	46,70	A
	3448080	Aluminium Flex Laminaat Ø 150 mm L = 10 meter	58,20	A
Akoestische slang	3448090	Akoestische / thermische Flex slang Ø 125 mm L = 3000 mm	406,00	A
	3448055	Akoestische / thermische Flex slang Ø 150 mm L = 3000 mm	46,70	A
	3140090	Geluiddempende slang SFD Ø 150 mm L = 1000 mm	62,30	A
Terugslagklep Los	3448100	Losse terugslagklep gegalvaniseerd Ø 100 mm	21,80	A
	3448110	Losse terugslagklep gegalvaniseerd Ø 125 mm	21,80	A
	3448120	Losse terugslagklep gegalvaniseerd Ø 150 mm	34,40	A
Muurdoover Set	3448130	Muurdoorvoerset met terugslagklep Ø 100 mm	47,50	A
	3448135	Muurdoorvoerset met terugslagklep Ø 125 mm	47,50	A
	3448140	Muurdoorvoerset met terugslagklep Ø 150 mm	51,30	A
RVS Slangklem	3448150	RVS Slangklem Ø 60 - 145 mm	1,80	A
	3448160	RVS Slangklem Ø 60 - 180 mm	3,20	A
	3448170	RVS Slangklem Ø 60 - 215 mm	3,60	A
	3448180	RVS Slangklem Ø 60 - 325 mm	7,20	A
RVS Bol Buitenrooster	3448200	RVS Bol buitenrooster met gaas Ø 100 mm	25,50	A
	3448210	RVS Bol buitenrooster met gaas Ø 125 mm	28,60	A
	3448220	RVS Bol buitenrooster met gaas Ø 150 mm	36,00	A
RVS Bol Buitenrooster	3448205	RVS Buitenrooster schuin met gaas Ø 100 mm	29,70	A
	3448215	RVS Buitenrooster schuin met gaas Ø 125 mm	35,10	A
	3448225	RVS Buitenrooster schuin met gaas Ø 150 mm	42,50	A
Uni Gevelklep	3448280	Uni Gevelklep wit kunststof Ø 100 / 125 mm	6,00	A
	3448285	Uni Gevelklep bruin kunststof Ø 100 / 125 mm	6,00	A
Verst. Rooster	3448290	Verstelbaar ventilatierooster Ø 100 / 150 mm wit kunststof	29,80	A
Natuurlijke Ontluchting Bovenkap	5800105	Coxvent 300 PP bovenkap ontluchting Ø 90 - 100 mm	14,50	A
	5800100	Coxvent 300 PP bovenkap ontluchting Ø 110 - 125 mm	15,20	A
	5800110	Coxvent 300 PP bovenkap ontluchting Ø 150 - 160 mm	24,90	A
Natuurlijke Ontluchting Plakplaat EW	5800205	Coxvent 300 plakplaat enkelwandig Ø 90 - 100 mm	24,00	A
	5800200	Coxvent 300 plakplaat enkelwandig Ø 110 - 125 mm	27,40	A
	5800210	Coxvent 300 plakplaat enkelwandig Ø 150 - 160 mm	35,40	A
Natuurlijke Ontluchting Plakplaat DW	5800305	Coxvent 300 plakplaat dubbelwandig Ø 90 - 100 mm	37,60	A
	5800300	Coxvent 300 plakplaat dubbelwandig Ø 110 - 125 mm	43,10	A
	5800310	Coxvent 300 plakplaat dubbelwandig Ø 150 - 160 mm	57,00	A



VENTILATIESYSTEMEN

Ventilatie-roosters

Schoepen-rooster



Artikelnr.	Omschrijving	Brutoprijs	Krt.G
3500010	Alu Schoepenrooster 300 x 90 mm kleine schoepen	4,10	A
3500020	Alu Schoepenrooster 200 x 200 mm kleine schoepen	4,80	A
3500030	Alu Schoepenrooster 250 x 200 mm kleine schoepen	5,50	A
3500040	Alu Schoepenrooster 160 x 160 mm kleine schoepen	3,90	A
3500050	Alu Schoepenrooster 130 x 90 mm kleine schoepen	3,50	A
3500060	Alu Schoepenrooster 180 x 90 mm kleine schoepen	3,70	A
3500070	Alu Schoepenrooster 250 x 250 mm kleine schoepen vlak model	8,50	A

Schoepen-rooster Wit



3500100	Alu Schoepenrooster 200 x 200 mm wit kleine schoepen	7,50	A
3500110	Alu Schoepenrooster 300 x 90 mm wit kleine schoepen	6,30	A
3500120	Alu Schoepenrooster 250 x 200 mm wit kleine schoepen	8,60	A
3500130	Alu Schoepenrooster 160 x 160 mm wit kleine schoepen	5,90	A
3500140	Alu Schoepenrooster 130 x 90 mm wit kleine schoepen	4,90	A
3500150	Alu Schoepenrooster 180 x 90 mm wit kleine schoepen	7,00	A

Schoepen-rooster RVS



3500210	RVS Schoepenrooster 130 x 90 mm	12,90	A
3500220	RVS Schoepenrooster 180 x 90 mm	13,50	A
3500230	RVS Schoepenrooster 160 x 160 mm	19,40	A
3500240	RVS Schoepenrooster 300 x 90 mm	18,20	A
3500250	RVS Schoepenrooster 250 x 200 mm	26,30	A
3500260	RVS Schoepenrooster 200 x 200 mm	22,00	A

Schoepen-rooster Bold Line

3500300	Alu Schoepenrooster 250 x 250 mm bold line	11,00	A
3500310	Alu Schoepenrooster 250 x 300 mm bold line	12,80	A
3500320	Alu Schoepenrooster 250 x 150 mm bold line	6,20	A
3500330	Alu Schoepenrooster 250 x 200 mm bold line	8,70	A

Ventilatie Rooster

3500350	Afsluitbaar vent.rooster 250 x 200mm wit met trekkoord	6,60	A
3500360	Afsluitbaar vent.rooster 160 x 160mm wit met trekkoord	6,00	A
3500370	Afsluitbaar vent.rooster 200 x 200mm wit met trekkoord	6,60	A
3500380	Afsluitbaar vent.rooster 250 x 80mm wit met schuif	5,20	A

Schuif Rooster

3500400	Alu Schuifrooster 160 x 160mm met gaas wit met draaiknop	10,90	A
3500410	Alu Schuifrooster 200 x 200mm met gaas wit met draaiknop	13,50	A
3500420	Alu Schuifrooster 250 x 200mm met gaas wit met draaiknop	16,70	A



VENTILATIESYSTEMEN

Bevestigingsmaterialen

Beugel met inleg



Artikelnr.	Omschrijving	Brutoprijs	Krt.G
3600010	Geg. beugel met inlage M8/10 Ø 79-85mm	4,00	A
3600015	Geg. beugel met inlage M8/10 Ø 95-102mm	5,30	A
3600020	Geg. beugel met inlage M8/10 Ø 100 mm	2,70	A
3600025	Geg. beugel met inlage M8/10 Ø 108-116 mm	13,40	A
3600030	Geg. beugel met inlage M8/10 Ø 125 mm	3,00	A
3600035	Geg. beugel met inlage M8/10 Ø 133-141 mm .	14,90	A
3600040	Geg. beugel met inlage M8/10 Ø 150 mm	3,70	A
3600045	Geg. beugel met inlage M8 Ø 160 mm	7,80	A
3600049	Geg. beugel met inlage M8/10 Ø 180mm	9,70	A
3600050	Geg. beugel met inlage M8/10 Ø 200mm	9,80	A
3600060	Geg. beugel met inlage M8/10 Ø 250mm	11,00	A

Beugel zonder inleg



3414604	Spiralo verzinkte beugel Ø 80 mm	3,50	A
3414605	Spiralo verzinkte beugel Ø 100 mm	3,60	A
3414606	Spiralo verzinkte beugel Ø 125 mm	3,70	A
3414607	Spiralo verzinkte beugel Ø 150 mm	4,30	A
3414608	Spiralo verzinkte beugel Ø 160 mm	4,60	A
3414609	Spiralo verzinkte beugel Ø 180 mm	5,50	A
3414610	Spiralo verzinkte beugel Ø 200 mm	5,70	A
3414612	Spiralo verzinkte beugel Ø 250 mm	7,10	A
3414614	Spiralo verzinkte beugel Ø 300 mm	8,50	A
3414615	Spiralo verzinkte beugel Ø 315 mm	9,10	A
3414616	Spiralo verzinkte beugel Ø 355 mm	10,10	A
3414617	Spiralo verzinkte beugel Ø 400 mm	10,20	A
3414618	Spiralo verzinkte beugel Ø 450 mm	13,60	A
3414619	Spiralo verzinkte beugel Ø 500 mm	13,80	A

Houtdraad bout



3414625	Houtdraadbout M8 * 50 mm, gegalvaniseerd	0,90	A
3414623	Houtdraadbout M8 * 120 mm, gegalvaniseerd	1,20	A
3414624	Houtdraadbout M8 * 160 mm, gegalvaniseerd	1,30	A

Tape



3600405	PVC tape Breed 50mm Rol 10 meter	3,20	A
3600400	PVC tape Breed 50mm Rol 20 meter	7,70	A
3600420	Aluminium tape 50mm Rol 50 meter	25,90	A

Diversen



3415000	Zelfborende plaatschroef 1/4" 3,5 x 9,5 mm 1000 stuks	91,80	A
3415005	Zelfborende plaatschroef 4,2 x 13 mm + bit 1000 stuks	61,50	A
3415006	Zelfborende plaatschroef 4,2 x 16 mm + bit 1000 stuks	66,60	A
3415010	Montageband 17 x 0.8mm L = 10 meter Gat 5,7mm	19,20	A
3600370	Draadstang M8 L=1000mm Geg.	2,50	A



VENTILATIESYSTEMEN

Zehnder Woonhuisventilatie

Zehnder Comfofan S



Artikelnr.	Omschrijving	Brutoprijs	Krt.G
3110000	Zehnder ComFofan S P	205,20	B
3110005	Zehnder ComFofan S RP	217,80	B
3110008	Zehnder ComFofan S RP + RFZ	277,20	B
3110010	Zehnder ComFofan S R	217,80	B
3110020	Zehnder Comfofan S R+RFZ	277,20	B
3110025	Zehnder ComFofan S CO2 (incl. HB)	478,80	B
3110001	Zehnder ComFofan S P hygro	253,80	B
3110002	Zehnder ComFofan S RP hygro	264,60	B
3110003	Zehnder ComFofan S R hygro	264,60	B
3110004	Zehnder ComFofan S R + RFZ hygro	324,00	B
3110006	Zehnder ComFofan S CO2 hygro	478,80	B
3110030	Zehnder RFZ zender	56,20	B
3110015	Zehnder timer RF	49,90	B

Zehnder Pijpventilatoren



3110055	Zehnder RPM 19/24 pijpventilator	344,50	B
3110056	Zehnder RPM 19/24 P pijpventilator (Perilex)	357,00	B
3110057	Zehnder RPMe pijpventilator	481,00	B
3110058	Zehnder RPMe P pijpventilator (Perilex)	491,00	B
3110065	Zehnder KPM 19/24 pijpventilator kort	357,00	B
3110067	Zehnder KPMe pijpventilator kort	491,00	B
3110059	Dakplaat platdak RPM / KPM	23,00	B
3110061	Zehnder print RF RPMe gecoot	70,80	B
3110030	Zehnder RFZ zender	56,20	B

Zehnder Dakventilatoren

3110075	Zehnder VPM 19/24 dakventilator	377,80	B
3110077	Zehnder VPMe dakventilator	544,00	B
3110030	Zehnder RFZ zender	56,20	B

Zehnder Wasemkappen

3110090	Zehnder WK 600/1 wasemkap	252,00	B
3110110	Zehnder WK 600/3 wasemkap	252,00	B

Keukenbox

3110120	Zehnder SKB keukenbox RAL 9010	45,40	B
---------	--------------------------------	-------	---

Zehnder WHR 918

31330010	Zehnder WTW-unit WHR 918	1594,00	B
31330020	Zehnder WTW-unit WHR 918 ERV	2115,00	B

Zehnder WHR 920



3131200	Zehnder WTW-unit WHR 920 basis L	2038,00	B
3131210	Zehnder WTW-unit WHR 920 basis R	2038,00	B
3131220	Zehnder WTW-unit WHR 920 basis RF L	2196,00	B
3131230	Zehnder WTW-unit WHR 920 basis RF R	2196,00	B
3131240	Zehnder WTW-unit WHR 920 Plus L	2325,00	B
3131250	Zehnder WTW-unit WHR 920 Plus R	2325,00	B
3131260	Zehnder Condensafvoer WHR	15,40	B
3131270	Zehnder Filterset WHR 920 G4 (2 st)	30,60	B



VENTILATIESYSTEMEN

Zehnder Woonhuisventilatie

Zehnder WHR 930



Artikelnr.	Omschrijving	Brutoprijs	Krt.G
3131300	Zehnder WTW-unit WHR 930 Basis L	1517,00	B
3131310	Zehnder WTW-unit WHR 930 Basis R	1517,00	B
3131320	Zehnder WTW-unit WHR 930 Basis RF L	1653,00	B
3131330	Zehnder WTW-unit WHR 930 Basis RF R	1653,00	B
3131340	Zehnder WTW-unit WHR 930 basis L ERV	2044,00	B
3131350	Zehnder WTW-unit WHR 930 basis R ERV	2044,00	B
3131360	Zehnder WTW-unit WHR 930 basis L RF ERV	2184,00	B
3131370	Zehnder WTW-unit WHR 930 basis R RF ERV	2184,00	B
3131380	Zehnder WTW-unit WHR 930 Onderstel	141,00	B
3131385	Zehnder WTW-unit WHR 930 Ophangframe	196,00	B
3131260	Zehnder Condensafvoer WHR	15,40	B
3131390	Zehnder Filterset WHR 930/950/960 (2 st)	18,00	B

Zehnder ComfoCool Q

31330100	Zehnder WTW-unit ComfoCool Q600 links	3.483,00	B
31330110	Zehnder WTW-unit ComfoCool Q600 rechts	3.483,00	B

Zehnder ComfoAir Q



31330120	Zehnder WTW-unit ComfoAir Q350 rechts	2.323,00	B
31330130	Zehnder WTW-unit ComfoAir Q350 links	2.323,00	B
31330140	Zehnder WTW-unit ComfoAir Q350 rechts ERV	2.942,00	B
31330150	Zehnder WTW-unit ComfoAir Q350 links ERV	2.942,00	B
31330160	Zehnder WTW-unit ComfoAir Q450 rechts	2.880,00	B
31330170	Zehnder WTW-unit ComfoAir Q450 links	2.880,00	B
31330180	Zehnder WTW-unit ComfoAir Q450 rechts ERV	3.499,00	B
31330190	Zehnder WTW-unit ComfoAir Q450 links ERV	3.499,00	B
31330200	Zehnder WTW-unit ComfoAir Q600 rechts	3.137,00	B
31330210	Zehnder WTW-unit ComfoAir Q600 links	3.137,00	B
31330220	Zehnder WTW-unit ComfoAir Q600 rechts ERV	3.756,00	B
31330230	Zehnder WTW-unit ComfoAir Q600 links ERV	3.756,00	B

Zehnder ComfoAir E



31330240	Zehnder WTW-unit ComfoAir E 300 rechts P	1.655,00	B
31330250	Zehnder WTW-unit ComfoAir E 300 links P	1.655,00	B
31330260	Zehnder WTW-unit ComfoAir E 300 rechts RF	1.813,00	B
31330270	Zehnder WTW-unit ComfoAir E 300 links RF	1.813,00	B
31330280	Zehnder WTW-unit ComfoAir E 400 rechts P	2.278,00	B
31330290	Zehnder WTW-unit ComfoAir E 400 links P	2.278,00	B
31330300	Zehnder WTW-unit ComfoAir E 400 rechts RF	2.434,00	B
31330310	Zehnder WTW-unit ComfoAir E 400 links RF	2.434,00	B

Zehnder ComfoSpot 50



31330350	Zehnder ComfoSpot 50 kunststof	908,00	B
31330360	Zehnder ComfoSpot 50 kunststof-RVS	1.060,00	B
31330370	Zehnder ComfoSpot 50 CO2 kunststof	1.212,00	B
31330380	Zehnder ComfoSpot 50 CO2 kunststof-RVS	1.382,00	B

Zehnder ComfoAir 70



31330400	Zehnder ComfoAir 70 aluminium-aluminium	1.352,00	B
31330410	Zehnder ComfoAir 70 aluminium-kunststof	1.399,00	B
31330420	Zehnder ComfoAir 70 aluminium-RVS	1.414,00	B
31330430	Zehnder ComfoAir 70 CO2 aluminium-aluminium	1.653,00	B
31330440	Zehnder ComfoAir 70 CO2 aluminium-kunststof	1.565,00	B
31330450	Zehnder ComfoAir 70 CO2 aluminium-RVS	1.715,00	B

VENTILATIESYSTEMEN

Zehnder Dakventilatoren

**Zehnder MX 110
Dakventilator**



Artikelnr.	Omschrijving	Brutoprijs	Krt.G
3131000	Zehnder dakventilator MX 110 D + WS	1014,00	B
3131010	Zehnder dakventilator MX 110 + WS	950,00	B
3131080	Zehnder dakventilator MX 110 D ZMV + WS	1382,00	B
3131090	Zehnder dakventilator MX 110 ZMV + WS	1315,00	B
3131710	Zehnder dakopstand DOS 330	113,50	B
3131830	Zehnder geluiddemper GDH 330	217,00	B
3131950	Zehnder pakkingplaat PV 330	12,50	B

**Zehnder MX 210
Dakventilator**



3131020	Zehnder dakventilator MX 210 D + WS	1222,00	B
3131030	Zehnder dakventilator MX 210 + WS	1149,00	B
3131100	Zehnder dakventilator MX 210 D ZMV + WS	1584,00	B
3131110	Zehnder dakventilator MX 210 ZMV + WS	1510,00	B
3131720	Zehnder dakopstand DOS 450	135,00	B
3131840	Zehnder geluiddemper GDH 450	263,00	B
3131960	Zehnder pakkingplaat PV 450	14,00	B

**Zehnder MX 310
Dakventilator**



3131040	Zehnder dakventilator MX 310 D + WS	1448,00	B
3131050	Zehnder dakventilator MX 310 + WS	1378,00	B
3131120	Zehnder dakventilator MX 310 D ZMV + WS	1811,00	B
3131130	Zehnder dakventilator MX 310 ZMV + WS	1741,00	B
3131730	Zehnder dakopstand DOS 535	189,00	B
3131850	Zehnder geluiddemper GDH 535	375,00	B
3131970	Zehnder pakkingplaat PV 535	15,90	B

**Zehnder MX 320
Dakventilator**



3131060	Zehnder dakventilator MX 320 D + WS	1986,00	B
3131070	Zehnder dakventilator MX 320 + WS	1906,00	B
3131140	Zehnder dakventilator MX 320 D ZMV + WS	2342,00	B
3131150	Zehnder dakventilator MX 320 ZMV + WS	2255,00	B
3131730	Zehnder dakopstand DOS 535	189,00	B
3131850	Zehnder geluiddemper GDH 535	375,00	B
3131970	Zehnder pakkingplaat PV 535	15,90	B

**Zehnder
Schakelaar**



3130295	Zehnder schakelaar SAG 0-M	73,80	B
3130296	Zehnder schakelaar SAG 0-5	73,80	B

* Projectprijzen op aanvraag



VENTILATIESYSTEMEN

Zehnder Dakventilatoren - Kanaalventilatoren

Zehnder VDX 110 Dakventilator



Artikelnr.	Omschrijving	Brutoprijs	Krt.G
3131600	Zehnder dakventilator VDX 110 D + WS	902,00	B
3131605	Zehnder dakventilator VDX 110 + WS	838,00	B
3131640	Zehnder dakventilator VDX 110 D 0-10 V + WS	926,00	B
3131645	Zehnder dakventilator VDX 110 0-10 V + WS	863,00	B
3131710	Zehnder dakopstand DOS 330	113,50	B
3131830	Zehnder geluiddemper GDH 330	217,00	B
3131950	Zehnder pakkingplaat PV 330	12,50	B

Zehnder VDX 210 Dakventilator



3131610	Zehnder dakventilator VDX 210 D + WS	1102,00	B
3131615	Zehnder dakventilator VDX 210 + WS	1029,00	B
3131650	Zehnder dakventilator VDX 210 D 0-10 V + WS	1126,00	B
3131655	Zehnder dakventilator VDX 210 0-10 V + WS	1053,00	B
3131720	Zehnder dakopstand DOS 450	135,00	B
3131840	Zehnder geluiddemper GDH 450	263,00	B
3131960	Zehnder pakkingplaat PV 450	14,00	B

Zehnder VDX 310 Dakventilator



3131620	Zehnder dakventilator VDX 310 D + WS	1325,00	B
3131625	Zehnder dakventilator VDX 310 + WS	1253,00	B
3131660	Zehnder dakventilator VDX 310 D 0-10 V + WS	1325,00	B
3131665	Zehnder dakventilator VDX 310 0-10 V + WS	1278,00	B
3131730	Zehnder dakopstand DOS 535	189,00	B
3131850	Zehnder geluiddemper GDH 535	375,00	B
3131970	Zehnder pakkingplaat PV 535	15,90	B

Zehnder VDX 320 Dakventilator



3131630	Zehnder dakventilator VDX 320 D + WS	1843,00	B
3131635	Zehnder dakventilator VDX 320 + WS	1760,00	B
3131670	Zehnder dakventilator VDX 320 D 0-10 V + WS	1876,00	B
3131675	Zehnder dakventilator VDX 320 0-10 V + WS	1829,00	B
3131730	Zehnder dakopstand DOS 535	189,00	B
3131850	Zehnder geluiddemper GDH 535	375,00	B
3131970	Zehnder pakkingplaat PV 535	15,90	B

Zehnder Schakelaar

3130295	Zehnder schakelaar SAG 0-M	73,80	B
3130296	Zehnder schakelaar SAG 0-5	73,80	B

Zehnder Pasflens

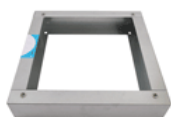

3132100	Zehnder pasflens 330 - 330	77,70	B
3132110	Zehnder pasflens 470 - 450	86,70	B
3132120	Zehnder pasflens 330 - 450	83,10	B
3132130	Zehnder pasflens 450 - 535	86,70	B
3132140	Zehnder pasflens 410 - 450	71,40	B
3132150	Zehnder pasflens 520 - 535	75,90	B
3132160	Zehnder pasflens 410 - 330	121,10	B
3132170	Zehnder pasflens 450 - 330	113,80	B
3132180	Zehnder pasflens 535 - 450	147,30	B
3132190	Zehnder pasflens 590 - 535	159,90	B
3132200	Zehnder pasflens 750 - 535	169,80	B

Centrifugaal Kanaalventilatoren

Zehnder CVF



3132261	Zehnder CVF 400/1000 CB1 TAC3	1369,00	B
3132260	Zehnder CVF 400/2000 CB1 TAC3	1530,00	B
3132270	Zehnder CVF 500/2900 CB1 TAC3	1596,00	B
3132280	Zehnder CVF 600/3800 CB1 TAC3	1801,00	B
3132290	Zehnder CVF 710/4400 CB1 TAC3	2141,00	B

VENTILATIESYSTEMEN

Zehnder Onderdelen Woonhuisventilatie

Comfofan S



Artikelnr.	Omschrijving	Brutoprijs	Krt.G
3111010	Ventilatordeel Comfofan S P	176,00	B
3111000	Ventilatordeel Comfofan S R	193,00	B
3111300	Ventilatordeel Comfofan S RP	193,00	B
3111020	Besturingsprint Comfofan S	90,50	B
3111030	Motor Comfofan S	185,00	B

CMF 14 (T)

3111060	Motor CMF 14 (R2E 180-CM26-09)	135,10	B
3111080	Motor CMF 14 T (R2E 180-CO06-09)	172,50	B
3111070	Condensatorblok CMF 14	14,90	B
3111090	Condensatorblok CMF 14 T	14,90	B

CMFe



3111110	Zehnder Serviceset motor CMFe P	169,50	B
3111120	Zehnder Serviceset motor CMFe R	169,50	B
3111100	Besturingsprint CMFe / CMFe R	111,20	B
3111310	PCB Ontvanger CMFe R	32,70	B

CME/CML 16

3111130	Motor CME/CML 16 (R4E 160-AA02-11)	125,80	B
3111140	Condenstaorblok CML 16	18,60	B

CME/ CML 14 (T)



3111160	Motor CME/CML 14/3-5-15 (R2E 140-AS77-37)	132,00	B
3111180	Motor CME/CML 14 T (R2E 140-B010-12)	177,80	B
3111170	Condensatorblok CML 14/3-5-15	18,60	B
3111190	Condensatorblok CML T 14/4-5-24	18,60	B
3111200	Condensatorblok CML 14/4-8-24	18,60	B

CMLe

3111210	Motor CMLe / CMLe R (R1G 140-AW03-19 DC)	141,40	B
3111230	Ontvanger NIKO 868	183,00	B

RPM / KPM / VPM

3111240	Serviceset RPM / KPM / VPM	221,00	B
3111250	Condensatorblok RPM/KPM/VPM	28,30	B

RPMe/KPMe / VPMe

3111260	Motor RPMe / KPMe / VPMe (Type R3G175-RF07-11-AC)	406,00	B
3111270	Print RPMe/KPMe/VPMe	134,10	B

Wasemkap WK 600



3111330	Lichtschakelaarset WK 600	9,80	B
3111340	Bedieningsknop WK 600	7,60	B
3111350	Klep WK 600	4,60	B
3111360	Snelsluitingset WK 600	11,30	B
3111370	Schakelaar WK 600/1	26,20	B
3111380	Schakelaar WK 600/2	69,40	B
3111390	Schakelaar WK 600/3	39,20	B
3111400	Front 2T. WK 600	18,90	B
3111410	Front 3T. WK 600	18,90	B



VENTILATIESYSTEMEN

Zehnder Onderdelen Woonhuisventilatie

WHR 90 / 91



Artikelnr.	Omschrijving	Brutoprijs	Krt.G
3111430	Ombouw voeding WHR 90 / 91	197,50	B
3111440	Motor WHR 90 (R1G-180-AC13-11 DC)	205,90	B
3111450	Motor WHR 91 (R1G 160-AD11-10 DC)	284,80	B
3111470	Voeding WHR 91 (S-150)	94,60	B
3111480	PTC voeler WHR	10,50	B
3111490	Besturingsprint WHR 90 / 91	312,90	B
3111500	Display WHR 90 / 91 / 950	52,00	B
3111510	Set trillingdempers WHR 91 / 950 (8 st)	22,50	B
3111520	Set trillingdempers WHR 90 (6 st)	6,60	B

WHR 920



3131270	Zehnder filterset WHR 920 G4/ISO Coarse (2 st)	30,60	B
3111530	Ventilator WHR 920 / CA200R	308,70	B
3111540	Ventilator WHR 920 / CA200L	308,70	B
3111550	Connection board Basic WHR 920	60,30	B
3111560	Display WHR 920	38,70	B
3111570	Voeler motor WHR 920 / CA200	14,60	B
3111580	Voeler bypass WHR 920 / CA200	21,50	B
3111590	Besturingsprint WHR 920 / CA200	120,60	B

WHR 930



3131390	Zehnder filterset WHR 930 / 950 / 960 G3/ISO Coarse	18,00	B
3111600	Motor WHR 930 (Type R3G 220-AD01-07)	243,30	B
3111610	Besturingsprint WHR 930	113,30	B
3111620	Display WHR 930	52,00	B
3111630	Voeler bypass / verwamer WHR 930	29,10	B
3111640	Connectieprint WHR 930 Luxe	219,30	B
3111650	RF print WHR 930	153,90	B
3111660	Voeler verwamer WHR 930	14,60	B
3111670	Servomotor + kabel WHR 930	56,20	B
3111680	Vorstvrij element WHR 930	136,10	B
3111690	Platenwisselaar WHR 930 / WHR 90 / WHR 91	328,30	B

WHR 950



3131390	Zehnder filterset WHR 930 / 950 / 960 G3/ISO Coarse	18,00	B
3111700	Motor WHR 950 (R1G 220-AB12-77) type tot medio 2008	316,00	B
3111710	Klep bypass WHR 950	16,50	B
3111720	PTC voeler WHR 950	10,90	B
3111730	Servomotor bypass WHR 950	101,90	B
3111740	Voeding WHR 950 (SP 200-51)	354,50	B
3111750	Besturingsprint WHR 950 B	315,00	B
3111500	Display WHR 90 / 91 / 950	52,00	B
3111760	Platenwisselaar WHR 950	468,00	B
3111510	Set trillingdempers WHR 91 / 950 (8 st)	22,50	B

Besturingsprint MX 10 / 20 / 30



3111770	Besturingsprint MX 10	540,50	B
3111780	Besturingsprint MX 20	565,50	B
3111790	Besturingsprint MX 30/10	573,80	B
3111800	Besturingsprint MX 30/20	596,70	B
3111810	Besturingsprint MX 10 ZMV	540,50	B
3111820	Besturingsprint MX 20 ZMV	565,50	B
3111830	Besturingsprint MX 30/10 ZMV	584,20	B
3111840	Besturingsprint MX 30/20 ZMV	596,70	B

VENTILATIESYSTEMEN

Zehnder Onderdelen Woonhuisventilatie

Besturingsprint MX



Artikelnr.	Omschrijving	Brutoprijs	Krt.G
3111850	Besturingsprint MX 110 gel.	219,30	B
3111855	Besturingsprint MX 210 gel.	219,30	B
3111860	Besturingsprint MX 310 gel.	219,30	B
3111865	Besturingsprint MX 320 gel.	219,30	B
3111870	Besturingsprint MX 110 ZMV geladen (tot januari 2015)	219,30	B
3111875	Besturingsprint MX 210 ZMV geladen (tot januari 2015)	219,30	B
3111880	Besturingsprint MX 310 ZMV geladen (tot januari 2015)	219,30	B
3111885	Besturingsprint MX 320 ZMV geladen (tot januari 2015)	219,30	B

Servicedeel MX

3111910	Motor + vleugel MX 110 Servicedeel	572,00	B
3111915	Motor + vleugel MX 210 Servicedeel	658,00	B
3111920	Motor + vleugel MX 310 Servicedeel	790,00	B
3111925	Motor + vleugel MX 320 Servicedeel	896,00	B

Ventilatie Ventielen

Zelfregelende Alize Ventielen



3300000	Zelfregelend ventiel Alize 15 m3/h	15,50	A
3300010	Zelfregelend ventiel Alize 30 m3/h	15,50	A
3300020	Zelfregelend ventiel Alize 45 m3/h	15,50	A
3300030	Zelfregelend ventiel Alize 60 m3/h	15,50	A
3300040	Zelfregelend ventiel Alize 75 m3/h	15,50	A
3300050	Zelfregelend ventiel Alize 90 m3/h	15,50	A
3300060	Zelfregelend ventiel Alize 15 - 30 m3/h	31,50	A
3300070	Zelfregelend ventiel Alize 20 - 75 m3/h	31,50	A
3300080	Zelfregelend ventiel Alize 30 - 90 m3/h	31,50	A
3300090	Zelfregelend ventiel Alize 45 - 105 m3/h	31,50	A
3300100	Zelfregelend ventiel Alize 45 - 120 m3/h	31,50	A
3300110	Zelfregelend ventiel Alize 45 - 135 m3/h	31,50	A
3300120	Alize montagering 100 mm safe	4,80	A
3300130	Alize montagering 116 mm safe	4,80	A
3300140	Alize Montagering 125 safe	4,80	A
3300170	Zelfregelend ventiel Alize Koorgeleider	3,20	A
3300180	Zelfregelend ventiel Alize Tussenring	3,80	A

R- vent ventielen



3140010	Kunststof afzuigventiel VEF 80	9,10	A
3140020	Kunststof afzuigventiel VEF 100	13,40	A
3140030	Kunststof afzuigventiel VEF 125	15,30	A
3140035	Kunststof afzuigventiel Ø 150	17,30	A

Zehnder Ventielen



3140040	Zehnder STK 100/125 afvoerventiel	3,70	B
3140050	Set schuimringen STK (3 stuks)	6,30	B
3140055	Zehnder STC 100/125 afvoerventiel	9,10	B
3140060	Zehnder STB 1-100 afvoerventiel	13,70	B
3140070	Zehnder STB 1-125 afvoerventiel	13,70	B
3140085	Zehnder ComfoValve Luna S125 toevoerventiel	21,80	B
3140086	Zehnder ComfoValve Luna Air blokker	4,00	B

RVS Ventielen



3448250	RVS afzuigventiel Ø 100 mm	28,50	A
3448260	RVS afzuigventiel Ø 125 mm	39,50	A
3448270	RVS afzuigventiel Ø 150 mm	42,50	A

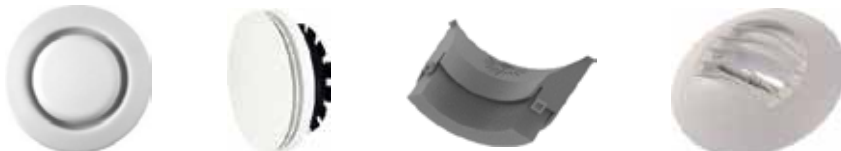

VENTILATIESYSTEMEN

Toilet / Badkamerventilatoren

Toilet / Bad
Ventilatoren
Silent/Decor 100



Artikelnr.	Omschrijving	Brutoprijs	Krt.G
3310000	Toilet / Badkamerventilator Silent 100 CZ standaard	112,40	B
3310010	Toilet / Badkamerventilator Silent 100 CRZ Timer	169,30	B
3310020	Toilet / Badkamerventilator Silent 100 CHZ Visual	259,10	B
3310040	Toilet / Badkamerventilator Silent 100 CDZ Bewegingssensor	245,90	B
3310050	Toilet / Badkamerventilator Decor 100 CHZ Hygro + Timer	190,80	B
3310060	Toilet / Badkamerventilator Decor 100 CDZ Bewegingssensor	191,90	B
3310070	Toilet / Badkamerventilator Silent 100 CZ Design Standaard	161,00	B
3310080	Toilet / Badkamerventilator Decor 100 CRZ Timer	158,80	B
3310090	Toilet / Badkamerventilator Silent 100 CRZ Design ECO	234,90	B
3310100	Toilet / Badkamerventilator Decor 100 CZ standaard	103,70	B
3310110	Toilet / Badkamerventilator Silent 100 Design CHZ ECO	261,40	B
3310120	Toilet / Badkamerventilator Decor 100 CHZ Visual	241,50	B

Toilet / Bad
Ventilatoren
Silent 200/300



3310130	Toilet / Badkamerventilator Silent 200 CHZ Hygro + Timer	267,80	B
3310140	Toilet / Badkamerventilator Silent 200 CRZ Timer	198,00	B
3310150	Toilet / Badkamerventilator Silent 200 CZ Design Standaard	140,80	B
3310160	Toilet / Badkamerventilator Silent 200 CRZ Design Timer	216,30	B
3310170	Toilet / Badkamerventilator Silent 200 Design CHZ Hygro+Timer	294,10	B
3310180	Toilet / Badkamerventilator Silent 200 CZ Standaard	123,60	B
3310190	Toilet / Badkamerventilator Silent 300 CZ Standaard	165,90	B
3310200	Toilet / Badkamerventilator Silent 300 CRZ Timer	206,00	B
3310210	Toilet / Badkamerventilator Silent 300 CHZ Hygro + Timer	288,50	B

Intellivent

3310300	Badkamerventilator Nedco INTELLIVENT 2.0 Wit	240,50	A
---------	--	--------	---

Svara

3310350	Badkamerventilator Svara Wit	286,30	A
---------	------------------------------	--------	---



Intellivent



Svara

CO₂
CO_{H2}



CO nach EN 50379-3



CO nach EN 50379-3



CO nach EN 50379-3

Brigon rookgasset



6530 BRIGON PM6530 in koffer



KANE77

Flexibiliteit en kwaliteit
voor de beste oplossing!



Haarlerberg 12 | 3825 CD Amersfoort | T +31 33 888 6799 | M +31 65 088 1549 |
E info@ktc-nederland.com | www.ktc-nederland.nl

HOOFDSTUK 12

Meetinstrumenten / Thermostaten

Omschrijving	Pagina
Diverse Meetinstrumenten en Analysers - koolmonixidemelder	122
Stuhl thermostaten t.b.v. verwarmen en koelen	123



MEETINSTRUMENTEN

	ArtikeInr.	Omschrijving	Brutoprijs	Krt.G
Rookgas Analyser Brigon 540	7700100	Brigon 540 Rookgasanalyser Basiskit standaard in doos	525,00	netto
	7700120	Brigon 540 Rookgasanalyser set met koffer	619,00	netto
	7700125	Brigon 540 Rookgasanalyser OKCV set incl. Brigon 3200	899,00	netto
Rookgas Analyser	7700440	Brigon 600 Rookgasanalyser set met koffer	822,90	netto
	7700420	Brigon 5740 Printer Infraroodinterface incl. beschermhoes	200,70	netto



Brigon 600



Kane 77 CO Meter

CO meter	7700030	Kane 77 Portabele CO meter, 0 / 999ppm incl. rubber holster	175,00	netto
----------	---------	---	--------	-------



Brigon PM 6530

Drukmeter Brigon PM 6530 3200	7700150	Brigon Drukverschilmeter PM 6530 0,,200 mbar/hPa	189,00	netto
	7700155	Brigon 3200 Drukverschilmeter	131,00	netto
	7700165	Zwarte koffer voor drukverschilmeter	38,00	netto
	7700160	KTC Dichtheidsbeproevingset	165,00	netto
	7700175	Set Brigon 3200 met koffer en dichtheidsbeproevingset	320,00	netto

Multimeter	7700130	Brigon digitale Multimeter DM 200	59,00	netto
------------	---------	-----------------------------------	-------	-------



Brigon 700

Gaslekzoeker	7700110	Brigon 700 Gaslekzoeker	174,00	netto
--------------	---------	-------------------------	--------	-------

CO-melder	7700050	ReTwist co-switsch koolmonoxidemelder	123,00	netto
-----------	---------	---------------------------------------	--------	-------



STUHL THERMOSTATEN

Artikelnr.	Omschrijving	Brutoprijs	Krt.G
------------	--------------	------------	-------

T.B.V. VERWARMEN

7100100	Stuhl SF20.T/2 thermostaat 24 Vac met Triac uitgang	66,30	A
7100110	Stuhl SF29.T/2 ruimtethermostaat 24Vac met Triac regeling	165,60	A
7100120	Stuhl SF50.T/2 thermostaat Triac 24 V	70,90	A
7100130	Stuhl SF200.R16/1 ruimtethermostaat relais,230V,incl. sensor	430,50	A
7100140	Stuhl SF220.T/2 klokthermostaat Triac versie 24V	252,50	A
7100220	RK201 Trafo 230/24 Vac, IP54, 35 VA	49,70	A



T.B.V. VERWARMEN EN KOELEN

7100150	Stuhl SFD20.T/2 24Vac display thermostaat	108,20	A
7100160	Stuhl SF13.T/2 thermostaat Triac schakeling 24 V	100,90	A
7100170	Stuhl SF22.2T/2 thermostaat 24 V 2 x Triac 4 pijps	115,00	A
7100180	Stuhl SF63.2T/2 Master regelaar voor omschakelen/aansturen	201,40	A
7100190	Stuhl SAM 8,1/1 klemlijst 230 V 8 kanaals, 8 thermostaten	181,10	A
7100200	Stuhl SAM 8,1/2 klemlijst 8 kanaals 24 V ac	185,80	A
7100210	Stuhl SF223.R10/2 klokthermostaat met wekklok 24V relais	252,50	A
7100220	RK201 Trafo 230/24 Vac, IP54, 35 VA	49,70	A

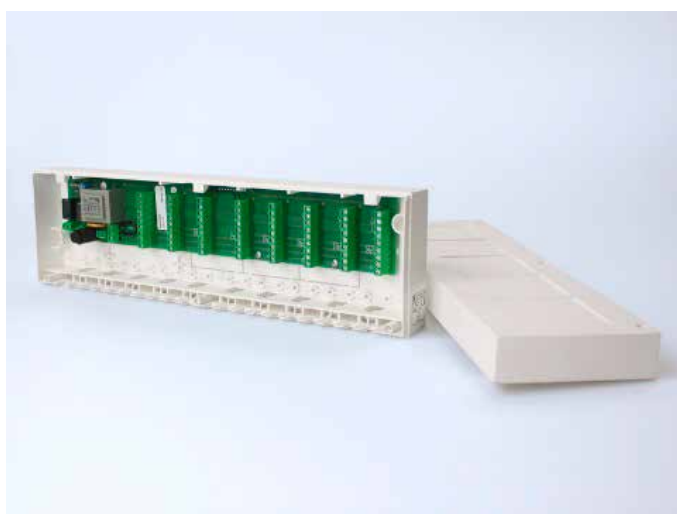

Schiedel ICS

Tabel met afmetingen voor asverschuivingen

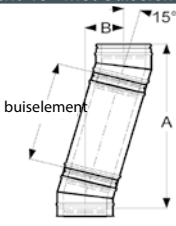
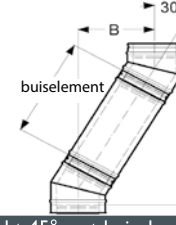
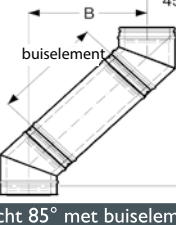
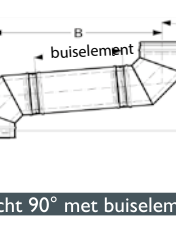
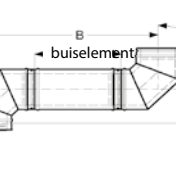
	int Ø mm	80	100	130	150	180	200	230	250	300	350	400	450	500	600	700
Bocht 15°																
zie afb. rechts	A	295	295	295	295	315	315	315	334	334	-	-	-	-	-	-
	B	39	39	39	39	41	41	41	44	44	-	-	-	-	-	-
Bocht 30°																
zie afb. rechts	A	280	299	327	336	355	373	373	392	411	448	537	556	575	631	687
	B	75	80	88	90	95	100	100	105	110	120	144	149	154	169	184
Bocht 45°																
zie afb. rechts	A	307	324	341	358	376	393	427	427	461	512	594	628	662	731	799
	B	127	134	141	148	156	163	177	177	191	212	246	260	274	303	331
Bocht 85°																
zie afb. rechts	A	322	337	372	391	424	450	480	500	552	609	641	852	907	1013	1120
	B	295	309	341	359	388	412	440	458	506	558	588	781	831	928	1026
Bocht 90°																
zie afb. rechts	A	300	316	348	366	396	420	452	468	518	572	620	830	880	980	1082
	B	300	316	348	366	396	420	452	468	518	572	620	830	880	980	1082
T-stuk 45° met bocht 45°																
zie afb. rechts	A	303	330	397	405	412	456	483	497	556	625	725	785	844	963	1086
	B	345	364	444	446	455	513	515	539	592	662	773	833	892	1016	1139
Bocht 15° met buiselement																
	buis	A	1218	1218	1218	1218	1238	1238	1238	1257	1257	-	-	-	-	-
	995	B	286	286	286	286	288	288	288	291	291	-	-	-	-	-
	buis	A	735	735	735	735	755	755	755	774	774	-	-	-	-	-
	455	B	157	157	157	157	159	159	159	162	162	-	-	-	-	-
	buis	A	493	493	493	493	513	513	513	532	532	-	-	-	-	-
	205	B	92	92	92	92	94	94	94	97	97	-	-	-	-	-
buis	A	445	445	445	445	465	465	465	484	484	-	-	-	-	-	
155	B	79	79	79	79	81	81	81	84	84	-	-	-	-	-	
Bocht 30° met buiselement																
	buis	A	1107	1126	1154	1163	1182	1200	1200	1219	1238	1275	1364	1383	1402	1458
	995	B	553	558	566	568	573	578	578	583	588	598	622	627	632	647
	buis	A	674	693	721	709	765	765	784	784	793	920	931	950	969	1025
	455	B	303	308	316	318	323	328	328	333	338	348	372	377	382	397
	buis	A	458	477	505	514	533	551	551	570	589	626	715	734	753	809
	205	B	178	183	191	193	198	203	203	208	213	223	247	252	257	272
buis	A	414	433	461	470	489	507	507	526	545	582	671	690	709	765	
155	B	153	158	166	168	173	178	178	183	188	198	222	227	232	247	
Bocht 45° met buiselement																
	buis	A	982	999	1016	1033	1051	1068	1102	1102	1136	1187	1269	1303	1337	1406
	995	B	802	809	816	823	831	838	852	852	866	887	921	935	949	978
	buis	A	629	646	663	680	698	715	749	749	783	834	916	950	984	1053
	455	B	449	456	463	470	478	485	499	499	513	534	568	582	596	625
	buis	A	452	469	486	503	521	538	572	572	606	657	739	773	807	876
	205	B	272	279	286	293	301	308	322	322	336	357	391	405	419	448
buis	A	417	434	451	468	486	503	537	537	571	622	704	738	772	841	
155	B	237	244	251	258	266	273	287	287	301	322	356	370	384	413	
Bocht 85° met buiselement																
	buis	A	405	420	455	474	507	533	563	583	635	692	724	935	990	1096
	995	B	1246	1260	1292	1310	1339	1363	1391	1409	1457	1509	1539	1732	1782	1879
	buis	A	362	377	412	431	464	490	520	540	592	649	681	892	947	1053
	455	B	748	762	794	812	841	865	893	911	959	1011	1041	1234	1284	1381
	buis	A	340	355	390	409	442	468	498	518	570	627	659	870	925	1031
	205	B	499	513	545	563	592	616	644	662	710	762	792	985	1035	1132
buis	A	335	350	385	404	437	463	493	513	565	622	654	865	920	1026	
155	B	449	463	495	513	542	566	594	612	660	712	742	935	985	1082	
Bocht 90° met buiselement																
	buis	A	300	316	348	366	396	420	452	468	518	572	620	830	880	980
	995	B	1255	1271	1303	1321	1351	1375	1407	1423	1473	1527	1575	1785	1835	1935
	buis	A	300	316	348	366	396	420	452	468	518	572	620	830	880	980
	455	B	755	771	803	821	851	875	907	923	973	1027	1075	1285	1335	1435
	buis	A	300	316	348	366	396	420	452	468	518	572	620	830	880	980
	205	B	505	521	553	571	601	625	657	673	723	777	825	1035	1085	1185
buis	A	300	316	348	366	396	420	452	468	518	572	620	830	880	980	
155	B	455	471	503	521	551	575	607	623	673	727	775	985	1035	1135	

Afb. Bocht 15°

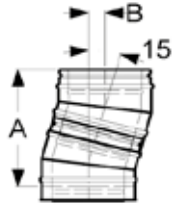

Afb. Bocht 30°

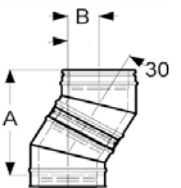

Afb. Bocht 45°

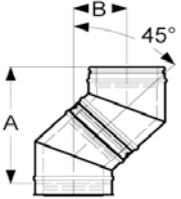

Afb. Bocht 85°

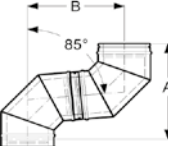

Afb. Bocht 90°

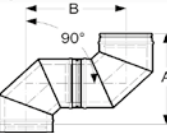

Afb. T-stuk 45° met bocht 45°

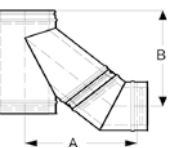

ROOKGASKANALEN

Schiedel ICS 25 - Dubbelwandig geïsoleerd

Nominale Diameter	2 x Bocht 15°		2 x Bocht 30°		2 x Bocht 45°	
	A	B	A	B	A	B
80 mm	295	39	280	75	307	127
100 mm	295	39	299	80	324	134
130 mm	295	39	327	88	341	141
150 mm	295	39	336	90	358	148
180 mm	315	41	355	95	376	156
200 mm	315	41	373	100	393	163
250 mm	334	44	392	105	427	177

Schiedel Prima Plus - Enkelwandig RVS

Nominale Diameter	2 x Bocht 15°		2 x Bocht 30°		2 x Bocht 45°	
	A	B	A	B	A	B
80 mm	218	29	226	60	266	110
100 mm	222	29	237	64	280	116
130 mm	230	30	252	68	335	139
150 mm	236	31	261	70	335	139
180 mm	244	32	276	74	369	153
200 mm	248	33	287	77	386	160
250 mm	261	34	312	81	406	168
300 mm	273	36	336	90	440	182

A = Totale hoogte maten in mm

B = Afstand hart op hart



Richtlijnen schoorsteendiameters bij (hout) kachels

Netto vermogen van de kachel	Schoorsteenhoogte					
	kW	3 meter	4,5 meter	6 meter	9 meter	15 meter
4.800	5,6	150 mm	130 mm	130 mm	130 mm	-
6.000	7,0	150 mm	130 mm	130 mm	130 mm	-
7.200	8,4	150 mm	130 mm	130 mm	130 mm	-
8.400	9,8	180 mm	150 mm	130 mm	130 mm	130 mm
9.600	11,2	180 mm	150 mm	150 mm	130 mm	130 mm
10.800	12,6	200 mm	180 mm	150 mm	150 mm	130 mm
12.000	14,0	200 mm	180 mm	150 mm	150 mm	150 mm
13.200	15,4	200 mm	180 mm	180 mm	150 mm	150 mm
14.400	16,8	200 mm	180 mm	180 mm	180 mm	150 mm
15.600	18,1	200 mm	200 mm	180 mm	180 mm	180 mm
16.800	19,6	250 mm	200 mm	180 mm	180 mm	180 mm
18.000	21,0	250 mm	200 mm	200 mm	180 mm	180 mm
19.200	22,3	250 mm	200 mm	200 mm	180 mm	180 mm
20.400	23,7	250 mm	200 mm	200 mm	200 mm	200 mm

B&E Installatie Groothandel Catalogus 2020

VENTILATIE

VENTILATIE VOLGENS BOUWBESLUIT 2012

Benodigde spleet onder een deur voor overstrom

Debiet		Deurbreedte					
M3 / uur	l / sec	50 cm	60 cm	70 cm	80 cm	90 cm	100 cm
GIW		3,5 cm	3,5 cm	3,5 cm	3,5 cm	3,5 cm	3,5 cm
10	2,8	0,7 cm	0,6 cm	0,5 cm	0,4 cm	0,4 cm	0,3 cm
20	5,6	1,3 cm	1,1 cm	1,0 cm	0,8 cm	0,7 cm	0,7 cm
30	8,3	2,0 cm	1,7 cm	1,4 cm	1,3 cm	1,1 cm	1,0 cm
40	11,1	2,7 cm	2,2 cm	1,9 cm	1,7 cm	1,5 cm	1,3 cm
50	13,9	3,4 cm	2,8 cm	2,4 cm	2,1 cm	1,9 cm	1,7 cm
60	16,7	4,0 cm	3,4 cm	2,9 cm	2,5 cm	2,2 cm	2,0 cm
70	19,4	4,7 cm	3,9 cm	3,4 cm	2,9 cm	2,6 cm	2,4 cm
80	22,2	5,4 cm	4,5 cm	3,8 cm	3,4 cm	3,0 cm	2,7 cm
90	25	6,1 cm	5,0 cm	4,3 cm	3,8 cm	3,4 cm	3,0 cm
100	27,8	6,7 cm	5,6 cm	4,8 cm	4,2 cm	3,7 cm	3,4 cm

Ventilatie eisen verblijfsgebieden (VG) bij geblanceerde ventilatie

Ruimte	Ventilatie in m3/uur	
Onderwijsfunctie	8,5 dm3/s = 30,6 m3/uur	Per persoon
Industriefunctie	6,5 dm3/s = 23,4 m3/uur	Per persoon
Sportfunctie	6,5 dm3/s = 23,4 m3/uur	Per persoon
Kantoorfunctie	6,5 dm3/s = 23,4 m3/uur	Per persoon
Vergader/docenten ruimte	55	Per persoon
Bijeenkomst ruimte	4,0 dm3/s = 14,4 m3/uur	Per persoon
Kleedruimte	11	Per m2
Garderobe en gangen	0,5	Per m2



VENTILATIE

Luchthoeveelheden (Q) in m³ / uur

Oppervlak in cm ²	Diameter	1	2	3	4	5	6
50 cm ²	80	18	37	55	73	91	110
79 cm ²	100	29	57	86	114	142	171
123 cm ²	125	45	89	134	178	223	268
177 cm ²	150	64	129	193	257	321	386
254 cm ²	180	93	185	278	370	463	555
314 cm ²	200	114	228	343	457	571	685
398 cm ²	225	145	289	434	578	723	868
491 cm ²	250	178	357	535	714	892	1071
616 cm ²	280	224	448	672	896	1120	1343
707 cm ²	300	257	514	771	1028	1285	1542
779 cm ²	315	283	567	850	1135	1417	1700
990 cm ²	355	360	720	1080	1440	1800	2160
1257 cm ²	400	457	914	1371	1828	2285	2742
1590 cm ²	450	578	1157	1735	2313	2892	3470
1963 cm ²	500	714	1428	2142	2856	3570	4284
2463 cm ²	560	896	1791	2687	3583	4478	5374
3117 cm ²	630	1134	2267	3401	4534	5668	6801
3959 cm ²	710	1440	2879	4319	5759	7199	8638
5027 cm ²	800	1828	3656	5484	7311	9139	10967
6362 cm ²	900	2313	4627	6940	9253	11567	13880
7854 cm ²	1000	2856	5712	8568	11424	14280	17136

Luchtsnelheid en -hoeveelheid in m³/uur in rechthoekige kanalen

Afmeting in mm	1 m/s	2 m/s	3 m/s	4 m/s	5 m/s	6 m/s
170 x 70	39	77	116	154	193	231
170 x 80	44	88	132	176	220	264
200 x 80	52	104	156	207	259	311
220 x 80	57	114	171	228	285	342



ROOKGASKANALEN

Diameterbepaling voor Openhaarden

Opening van de haard	Schoorsteenhoogte				
	3 meter	4.5 meter	6 meter	9 meter	15 meter
45 x 45	200 mm	180 mm	150 mm	150 mm	150 mm
45 x 55	200 mm	200 mm	180 mm	150 mm	150 mm
45 x 65	200 mm	200 mm	180 mm	150 mm	150 mm
45 x 75	250 mm	200 mm	180 mm	180 mm	180 mm
45 x 85	250 mm	250 mm	200 mm	180 mm	180 mm
45 x 95	250 mm	250 mm	200 mm	200 mm	180 mm
45 x 105	300 mm	250 mm	200 mm	200 mm	200 mm
45 x 115	300 mm	300 mm	250 mm	200 mm	200 mm
45 x 125	300 mm	300 mm	250 mm	200 mm	200 mm
45 x 135	300 mm	300 mm	250 mm	200 mm	200 mm
45 x 145	-	300 mm	250 mm	250 mm	250 mm
45 x 160	-	-	300 mm	250 mm	250 mm
45 x 180	-	-	300 mm	250 mm	250 mm
50 x 45	200 mm	200 mm	180 mm	180 mm	180 mm
50 x 55	200 mm	200 mm	180 mm	180 mm	180 mm
50 x 65	250 mm	200 mm	180 mm	180 mm	180 mm
50 x 75	250 mm	250 mm	200 mm	180 mm	180 mm
50 x 85	250 mm	250 mm	200 mm	200 mm	180 mm
50 x 95	300 mm	250 mm	200 mm	200 mm	180 mm
50 x 105	300 mm	300 mm	250 mm	200 mm	200 mm
50 x 115	300 mm	300 mm	250 mm	200 mm	200 mm
50 x 125	300 mm	300 mm	250 mm	200 mm	200 mm
50 x 135	300 mm	300 mm	250 mm	250 mm	250 mm
50 x 145	-	300 mm	250 mm	250 mm	250 mm
50 x 160	-	-	300 mm	250 mm	250 mm
50 x 180	-	-	300 mm	250 mm	250 mm
55 x 40	200 mm	200 mm	180 mm	180 mm	180 mm
55 x 50	250 mm	200 mm	180 mm	180 mm	180 mm
55 x 60	250 mm	250 mm	200 mm	180 mm	180 mm
55 x 80	300 mm	250 mm	200 mm	200 mm	180 mm
55 x 100	300 mm	300 mm	250 mm	200 mm	200 mm
55 x 140	-	300 mm	250 mm	250 mm	250 mm
55 x 160	-	-	300 mm	300 mm	250 mm
60 x 65	200 mm	200 mm	180 mm	180 mm	180 mm
60 x 70	250 mm	200 mm	200 mm	180 mm	180 mm
60 x 75	250 mm	200 mm	200 mm	200 mm	180 mm
60 x 100	300 mm	250 mm	250 mm	250 mm	200 mm
60 x 125	-	250 mm	250 mm	250 mm	250 mm
65 x 85	300 mm	300 mm	250 mm	200 mm	200 mm
65 x 115	-	300 mm	250 mm	250 mm	250 mm
65 x 145	-	-	300 mm	250 mm	250 mm

B&E Installatie Groothandel Catalogus 2020

